

NCP4589

300 mA, Tri-Mode, LDO Linear Voltage Regulator

The NCP4589 is a CMOS 300 mA LDO which switches to a low power mode under light current loads. The device automatically switches back to a fast response mode as the output load increases above 3 mA (typ.). The device can be placed in permanent fast mode through a mode select pin. The family is available in a variety of packages: SC-70, SOT23 and a small, ultra thin 1.2 x 1.2 x 0.4 mm XDFN.

Features

- Operating Input Voltage Range: 1.4 V to 5.25 V
- Output Voltage Range: 0.8 to 4.0 V (available in 0.1 V steps)
- Supply Current: Low Power Mode – 1.0 μ A at $V_{OUT} < 1.85$ V
Fast Mode – 55 μ A
Standby Mode – 0.1 μ A
- Dropout Voltage: 230 mV Typ. at $I_{OUT} = 300$ mA, $V_{OUT} = 2.8$ V
- $\pm 1\%$ Output Voltage Accuracy ($V_{OUT} > 2$ V, $T_J = 25$ °C)
- High PSRR: 70 dB at 1 kHz (Fast response mode)
- Line Regulation 0.02%/V Typ.
- Current Fold Back Protection
- Stable with Ceramic Capacitors
- Available in 1.2x1.2 XDFN, SC-70 and SOT23 Package
- These are Pb-free Devices

Typical Applications

- Battery Powered Equipments
- Portable Communication Equipments
- Cameras, Image Sensors and Camcorders

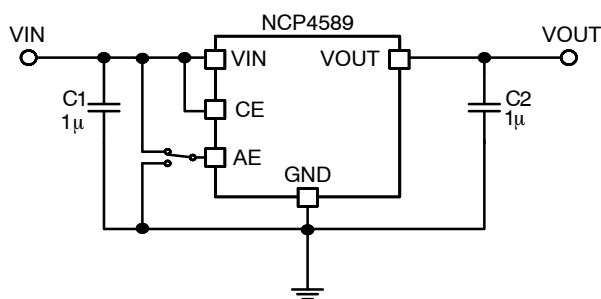


Figure 1. Typical Application Schematic



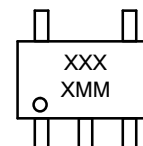
ON Semiconductor™

<http://onsemi.com>

MARKING DIAGRAMS



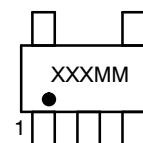
SC-70
CASE 419A



XDFN6
CASE 711AA



SOT-23-5
CASE 1212



XXXX = Specific Device Code
MM = Date Code

ORDERING INFORMATION

See detailed ordering and shipping information in the package dimensions section on page 27 of this data sheet.

NCP4589

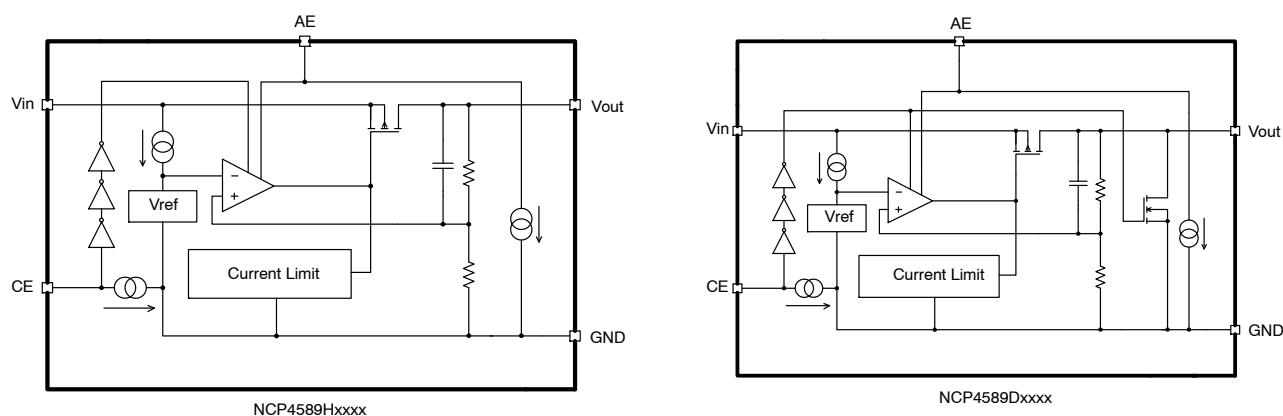


Figure 2. Simplified Schematic Block Diagram

PIN FUNCTION DESCRIPTION

Pin No. XDFN	Pin No. SC-70	Pin No. SOT23	Pin Name	Description
4	4	1	VIN	Input pin
2	2	2	GND	Ground
3	5	3	CE	Chip enable pin
6	3	5	VOUT	Output pin
1	1	4	AE	Auto Eco Pin
5	-	-	NC	No connection

ABSOLUTE MAXIMUM RATINGS

Rating	Symbol	Value	Unit
Input Voltage (Note 1)	V_{IN}	6.0	V
Output Voltage	V_{OUT}	-0.3 to $V_{IN} + 0.3$	V
Chip Enable Input	V_{CE}	-0.3 to 6.0	V
Auto Eco Input	V_{AE}	-0.3 to 6.0	V
Output Current	I_{OUT}	400	mA
Power Dissipation XDFN	P_D	400	mW
Power Dissipation SC70		380	
Power Dissipation SOT23		420	
Junction Temperature	T_J	-40 to 150	°C
Storage Temperature	T_{STG}	-55 to 125	°C
Operation Temperature	T_A	-40 to 85	°C
ESD Capability, Human Body Model (Note 2)	ESD_{HBM}	2000	V
ESD Capability, Machine Model (Note 2)	ESD_{MM}	200	V

Stresses exceeding Maximum Ratings may damage the device. Maximum Ratings are stress ratings only. Functional operation above the Recommended Operating Conditions is not implied. Extended exposure to stresses above the Recommended Operating Conditions may affect device reliability.

1. Refer to ELECTRICAL CHARACTERISTICS and APPLICATION INFORMATION for Safe Operating Area.
2. This device series incorporates ESD protection and is tested by the following methods:
 ESD Human Body Model tested per AEC-Q100-002 (EIA/JESD22-A114)
 ESD Machine Model tested per AEC-Q100-003 (EIA/JESD22-A115)
 Latchup Current Maximum Rating tested per JEDEC standard: JESD78.

NCP4589

THERMAL CHARACTERISTICS

Rating	Symbol	Value	Unit
Thermal Characteristics, XDFN Thermal Resistance, Junction-to-Air	$R_{\theta JA}$	250	$^{\circ}\text{C}/\text{W}$
Thermal Characteristics, SOT23 Thermal Resistance, Junction-to-Air	$R_{\theta JA}$	238	$^{\circ}\text{C}/\text{W}$
Thermal Characteristics, SC-70 Thermal Resistance, Junction-to-Air	$R_{\theta JA}$	263	$^{\circ}\text{C}/\text{W}$

ELECTRICAL CHARACTERISTICS

$-40^{\circ}\text{C} \leq T_A \leq 85^{\circ}\text{C}$; $V_{IN} = V_{OUT(NOM)} + 1\text{ V}$; $I_{OUT} = 1\text{ mA}$; $C_{IN} = C_{OUT} = 1\text{ }\mu\text{F}$; unless otherwise noted. Typical values are at $T_A = +25^{\circ}\text{C}$.

Parameter	Test Conditions		Symbol	Min	Typ	Max	Unit
Operating Input Voltage	(Note NO TAG)		V_{IN}	1.4		5.25	V
Output Voltage (Fast Mode)	$T_A = +25^{\circ}\text{C}$, $I_{OUT} = 5\text{ mA}$	$V_{OUT} > 2\text{ V}$	V_{OUT}	x0.99		x1.01	V
		$V_{OUT} \leq 2\text{ V}$		-20		20	mV
	$-40^{\circ}\text{C} \leq T_A \leq 85^{\circ}\text{C}$, $I_{OUT} = 5\text{ mA}$	$V_{OUT} > 2\text{ V}$		x0.975		x1.015	V
		$V_{OUT} \leq 2\text{ V}$		-50		30	mV
Output Voltage Temp. Coefficient	$T_A = -40\text{ to }85^{\circ}\text{C}$				± 50		ppm/ $^{\circ}\text{C}$
Line Regulation	$V_{IN} = V_{OUT} + 0.5\text{ V to }5\text{ V}$ $V_{IN} \geq 1.4\text{ V}$	$I_{OUT} = 1\text{ mA}$, (Low Power Mode)	$Line_{Reg}$			0.50	%/V
		$I_{OUT} = 10\text{ mA}$, (Fast Mode)			0.02	0.20	
Load Regulation	$I_{OUT} = 1\text{ mA to }10\text{ mA}$	$V_{OUT} > 2.0\text{ V}$	$Line_{Reg}$	-1.0		1.0	%
		$V_{OUT} \leq 2.0\text{ V}$		-20		20	mV
	$I_{OUT} = 10\text{ mA to }300\text{ mA}$					35	80
Dropout Voltage	$I_{OUT} = 300\text{ mA}$	$0.8\text{ V} \leq V_{OUT} < 0.9\text{ V}$	V_{DO}		0.62	0.85	V
		$0.9\text{ V} \leq V_{OUT} < 1.0\text{ V}$			0.55	0.78	
		$1.0\text{ V} \leq V_{OUT} < 1.5\text{ V}$			0.48	0.70	
		$1.5\text{ V} \leq V_{OUT} < 2.6\text{ V}$			0.34	0.50	
		$2.6\text{ V} \leq V_{OUT} < 4.0\text{ V}$			0.23	0.35	
Output Current			I_{OUT}	300			mA
Short Current Limit	$V_{OUT} = 0\text{ V}$		I_{SC}		50		mA
Quiescent Current	$I_{OUT} = 0\text{ mA}$, Low Power Mode (Note 3)	$V_{OUT} \leq 1.85\text{ V}$	I_Q		1.0	4.0	μA
		$V_{OUT} > 1.85\text{ V}$			1.5	4.0	
Supply Current	$I_{OUT} = 10\text{ mA}$, Fast Mode		I_{GND}		55		μA
Standby Current	$V_{CE} = 0\text{ V}$, $T_A = 25^{\circ}\text{C}$		I_{STB}		0.1	1	μA
Fast Mode Switch-Over Current	$I_{OUT} = \text{light to heavy load}$		I_{OUTH}			8.0	mA
Low Power Switch-Over Current	$I_{OUT} = \text{heavy to light load}$		I_{OUTL}	1.0	2.0		mA
CE Pin Threshold Voltage	CE Input Voltage "H"		V_{CEH}	1.0			V
	CE Input Voltage "L"		V_{CEL}			0.4	
CE Pull Down Current			I_{CEPD}		0.1		μA
AE Pin Threshold Voltage	AE Input Voltage "H"		V_{AEH}	1.0			V
	AE Input Voltage "L"		V_{AEL}			0.4	

3. The value of supply current is excluding the Pull-down constant current of CE and AE Pin

NCP4589

ELECTRICAL CHARACTERISTICS

$-40^{\circ}\text{C} \leq T_A \leq 85^{\circ}\text{C}$; $V_{IN} = V_{OUT(NOM)} + 1\text{ V}$; $I_{OUT} = 1\text{ mA}$; $C_{IN} = C_{OUT} = 1\text{ }\mu\text{F}$; unless otherwise noted. Typical values are at $T_A = +25^{\circ}\text{C}$.

Parameter	Test Conditions	Symbol	Min	Typ	Max	Unit
AE Pull Down Current		IAEPD		0.1		μA
Power Supply Rejection Ratio	$V_{IN} = V_{OUT} + 1\text{ V}$ or 2.2 V whichever is higher, $\Delta V_{IN} = 0.2\text{ V}_{pk-pk}$, $I_{OUT} = 30\text{ mA}$, $f = 1\text{ kHz}$, Fast Mode	PSRR		70		dB
Output Noise Voltage	$V_{OUT} = 1.0\text{ V}$, $I_{OUT} = 30\text{ mA}$, $f = 10\text{ Hz}$ to 100 kHz	V_N		90		μV_{rms}
Low Output N-channel Tr. On Resistance	$V_{IN} = 4\text{ V}$, $V_{CE} = 0\text{ V}$	R_{LOW}		50		Ω

3. The value of supply current is excluding the Pull-down constant current of CE and AE Pin

TYPICAL CHARACTERISTICS

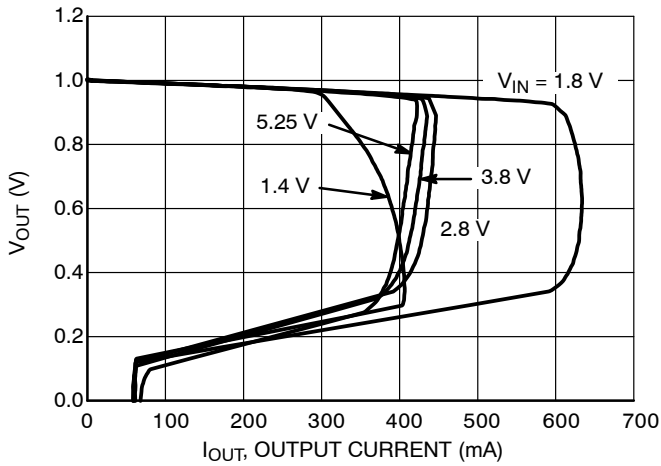


Figure 3. Output Voltage vs. Output Current
1.0 V Version ($T_J = 25^\circ\text{C}$)

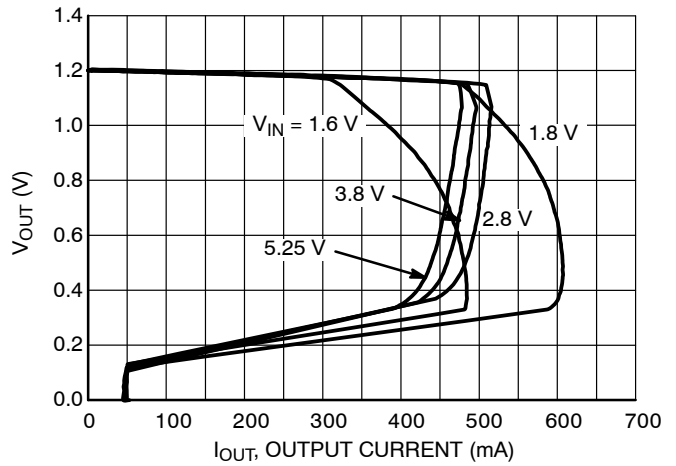


Figure 4. Output Voltage vs. Output Current
1.2 V Version ($T_J = 25^\circ\text{C}$)

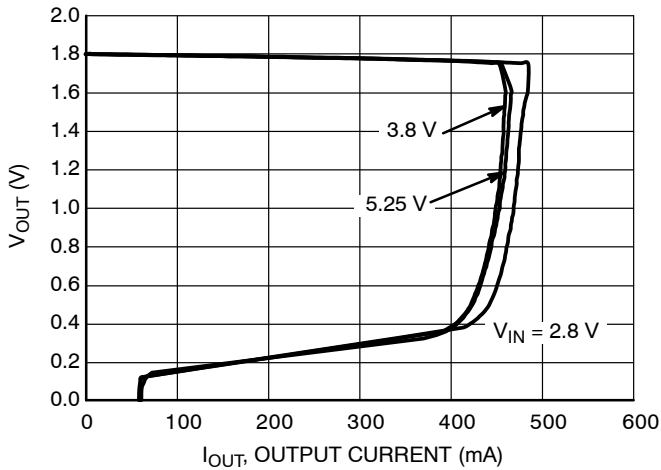


Figure 5. Output Voltage vs. Output Current
1.8 V Version ($T_J = 25^\circ\text{C}$)

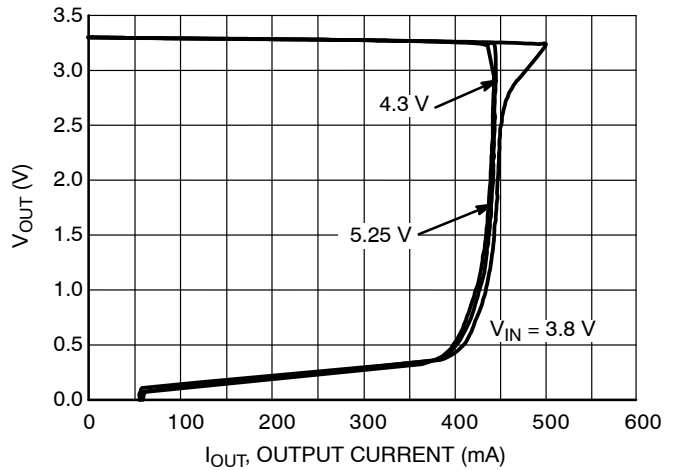


Figure 6. Output Voltage vs. Output Current
3.3 V Version ($T_J = 25^\circ\text{C}$)

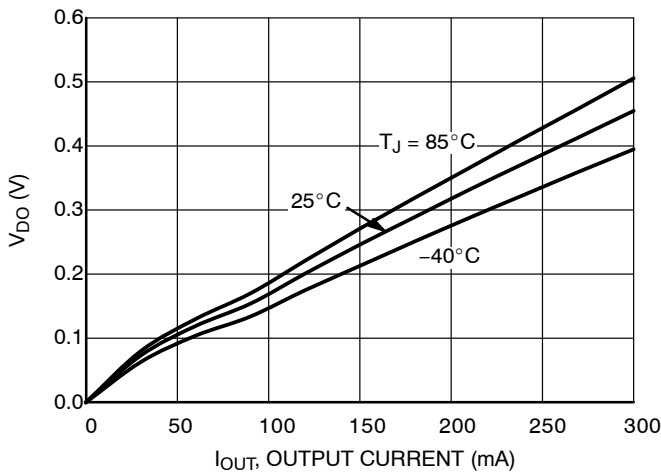


Figure 7. Dropout Voltage vs. Output Current
1.0 V Version

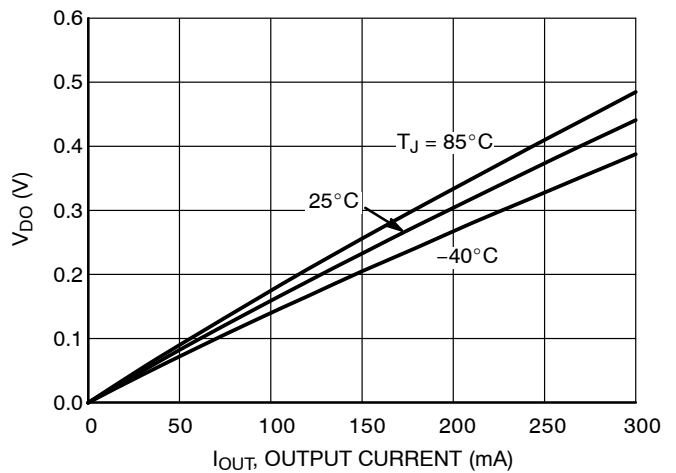


Figure 8. Dropout Voltage vs. Output Current
1.2 V Version

TYPICAL CHARACTERISTICS

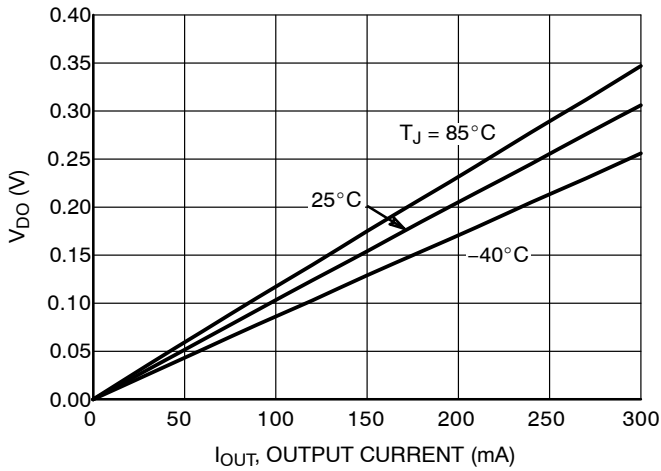


Figure 9. Dropout Voltage vs. Output Current
1.8 V Version

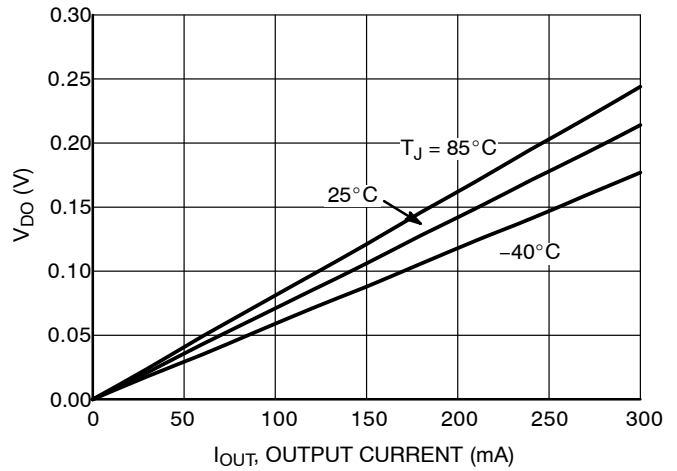


Figure 10. Dropout Voltage vs. Output Current
3.3 V Version

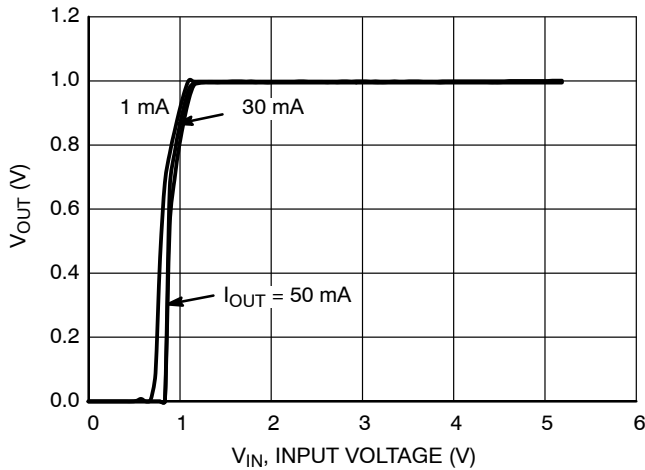


Figure 11. Output Voltage vs. Input Voltage,
1.0 V Version

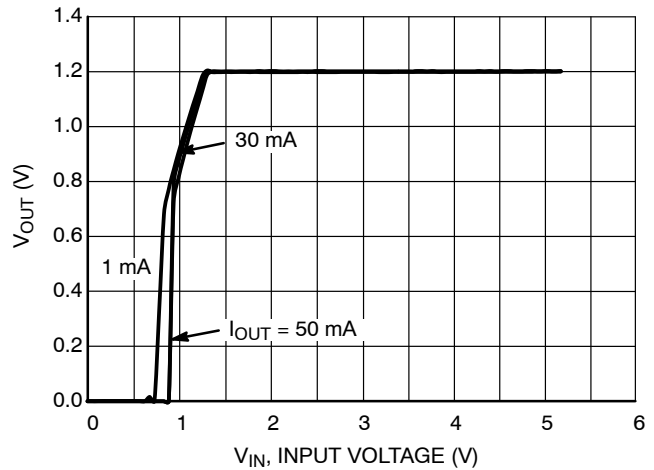


Figure 12. Output Voltage vs. Input Voltage,
1.2 V Version

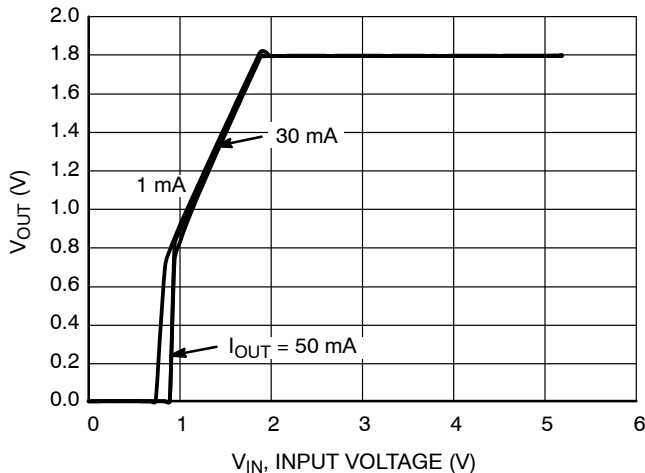


Figure 13. Output Voltage vs. Input Voltage,
1.8 V Version

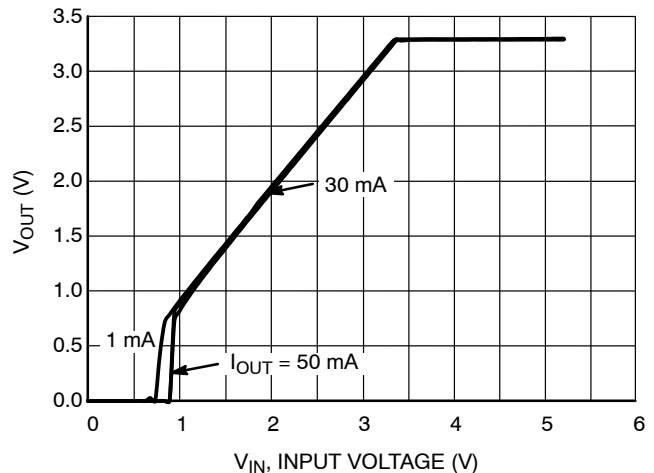


Figure 14. Output Voltage vs. Input Voltage,
3.3 V Version

TYPICAL CHARACTERISTICS

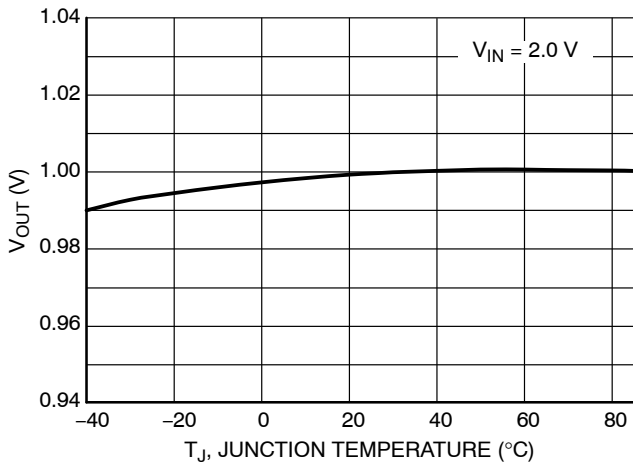


Figure 15. Output Voltage vs. Temperature, 1.0 V Version

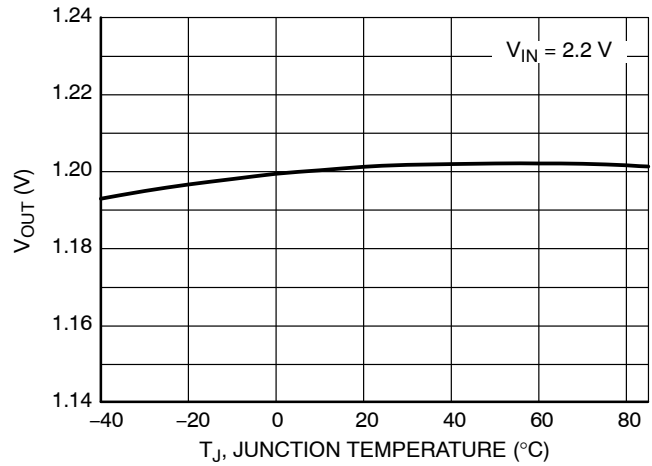


Figure 16. Output Voltage vs. Temperature, 1.2 V Version

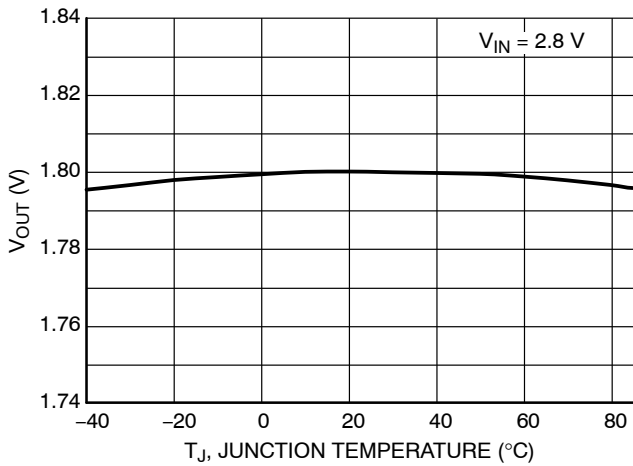


Figure 17. Output Voltage vs. Temperature, 1.8 V Version

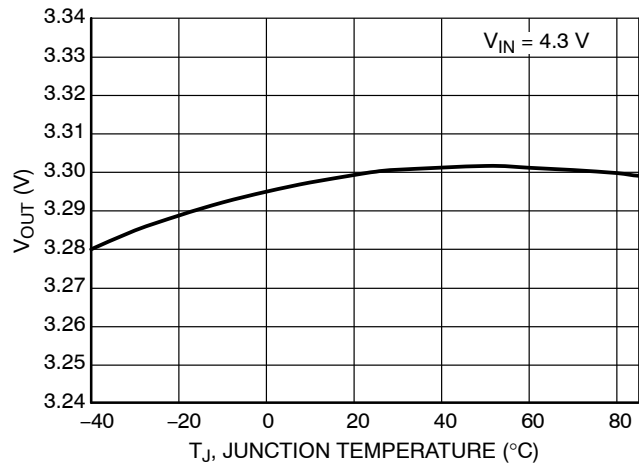


Figure 18. Supply Current vs. Input Voltage, 3.3 V Version

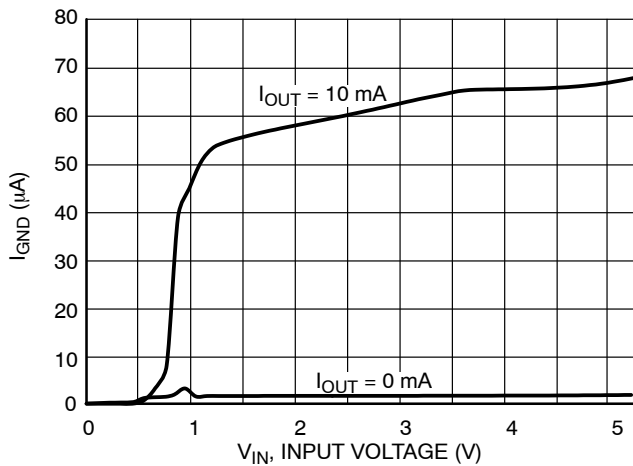


Figure 19. Supply Current vs. Input Voltage, 1.0 V Version

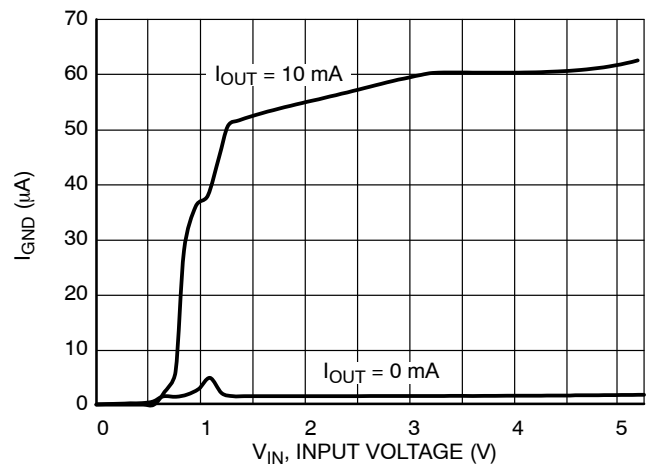


Figure 20. Supply Current vs. Input Voltage, 1.2 V Version

TYPICAL CHARACTERISTICS

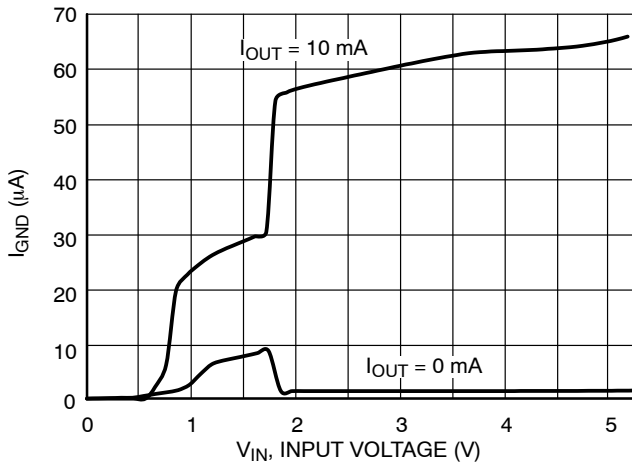


Figure 21. Supply Current vs. Input Voltage, 1.8 V Version

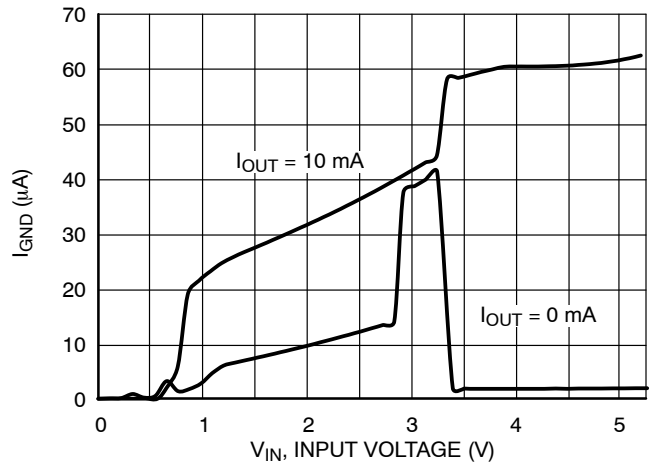


Figure 22. Supply Current vs. Input Voltage, 3.3 V Version

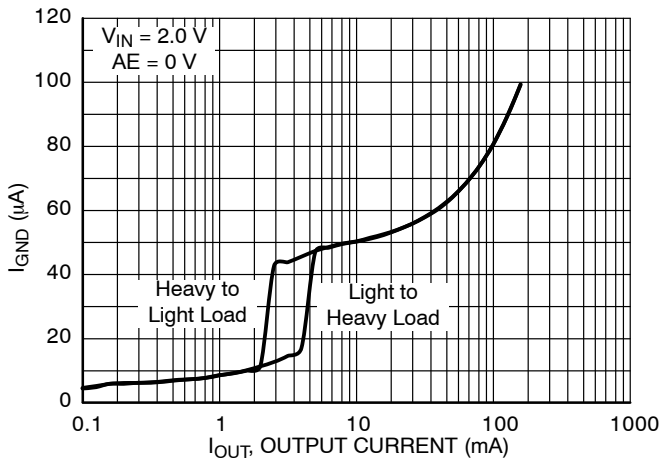


Figure 23. Supply Current vs. Output Current, 1.0 V Version

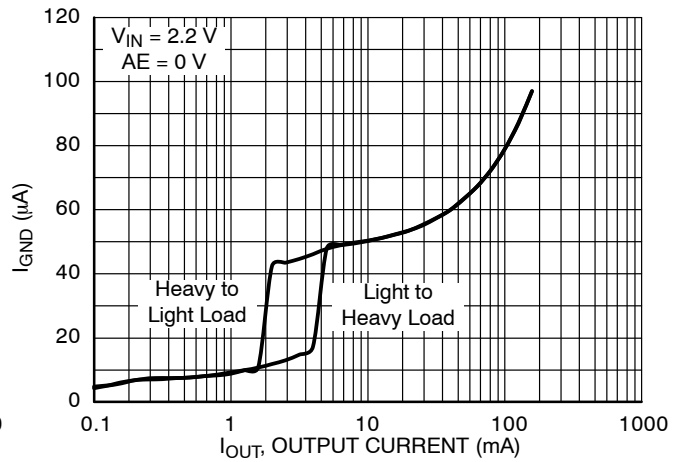


Figure 24. Supply Current vs. Output Current, 1.2 V Version

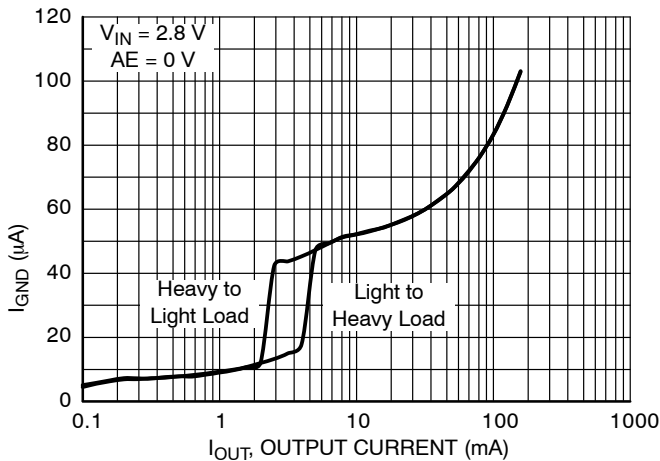


Figure 25. Supply Current vs. Output Current, 1.8 V Version

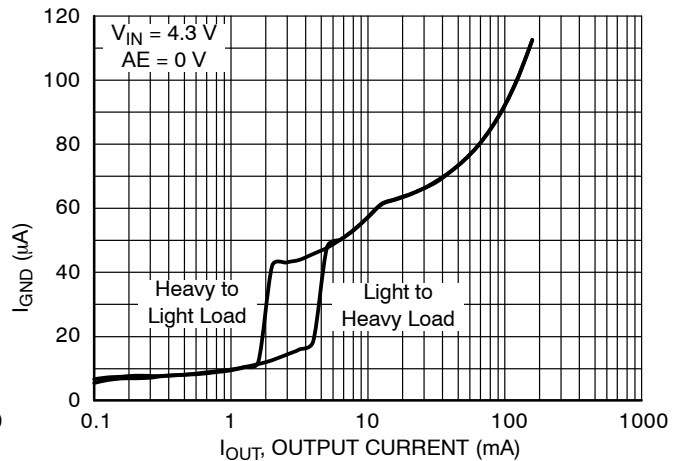


Figure 26. Supply Current vs. Output Current, 3.3 V Version

TYPICAL CHARACTERISTICS

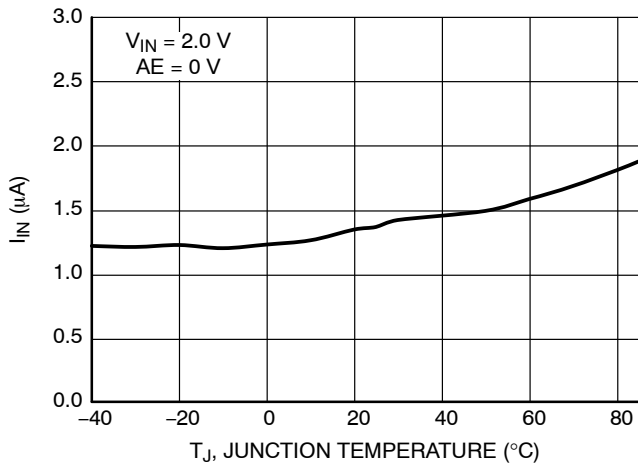


Figure 27. Supply Current vs. Temperature, 1.0 V Version

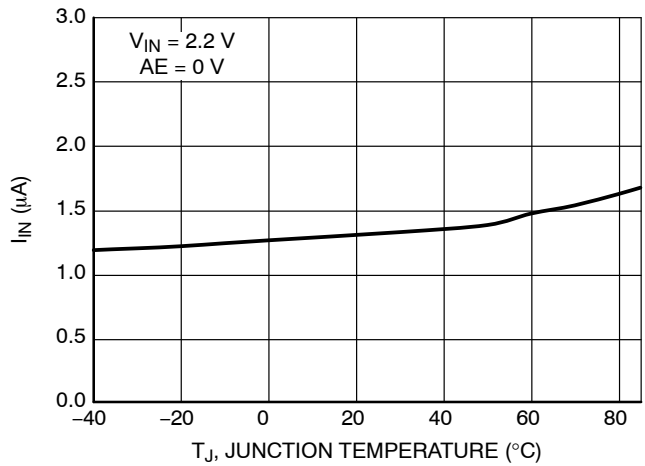


Figure 28. Supply Current vs. Temperature, 1.2 V Version

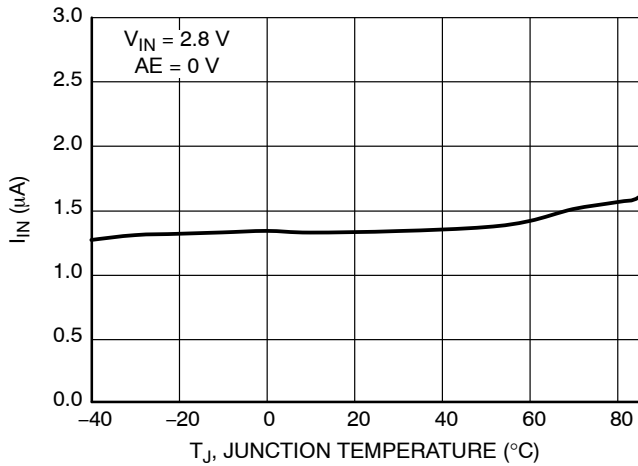


Figure 29. Supply Current vs. Temperature, 1.8 V Version

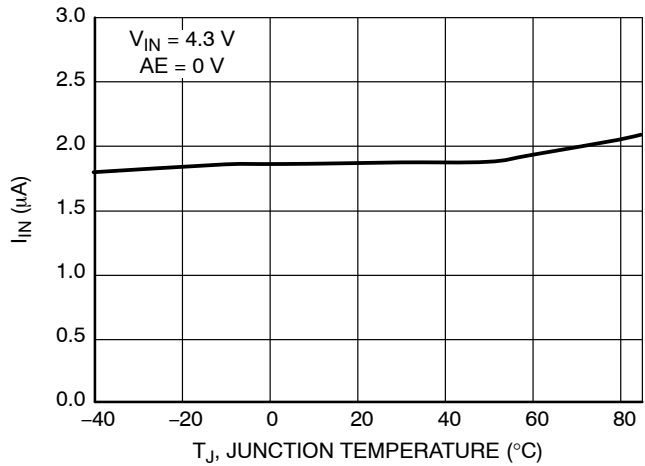


Figure 30. Supply Current vs. Temperature, 3.3 V Version

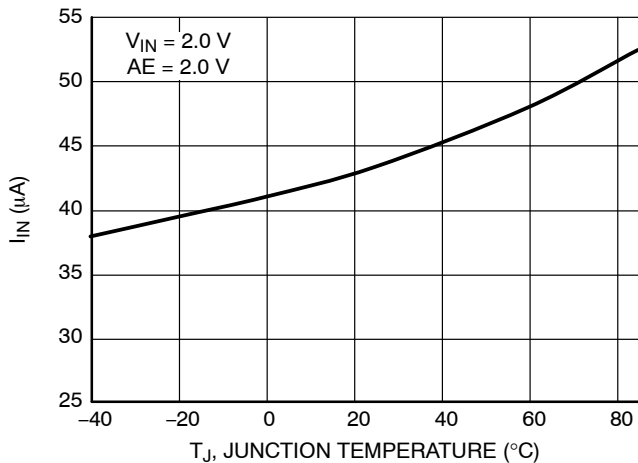


Figure 31. Supply Current vs. Temperature, 1.0 V Version

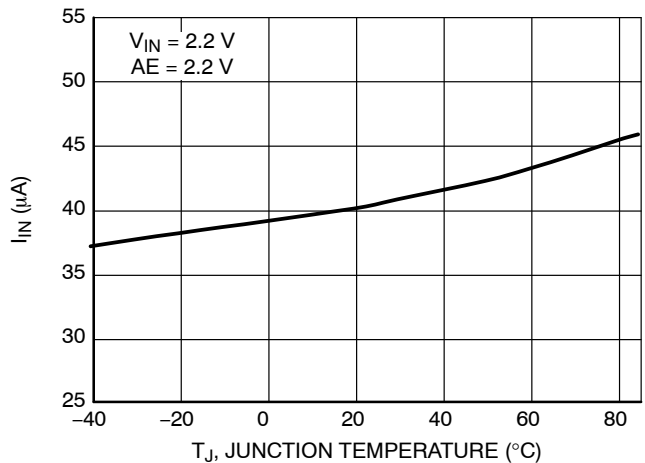


Figure 32. Supply Current vs. Temperature, 1.2 V Version

TYPICAL CHARACTERISTICS

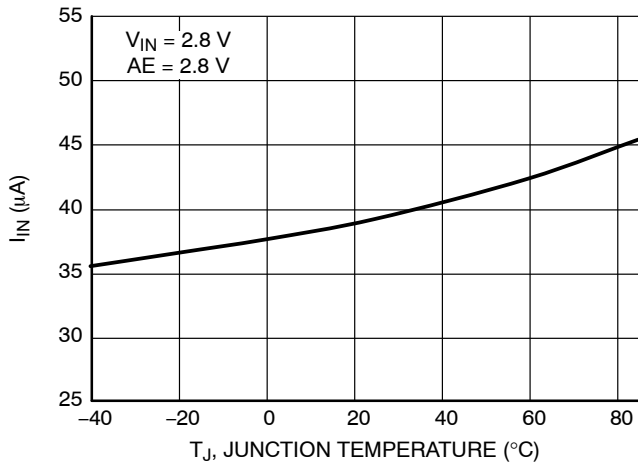


Figure 33. Supply Current vs. Temperature, 1.8 V Version

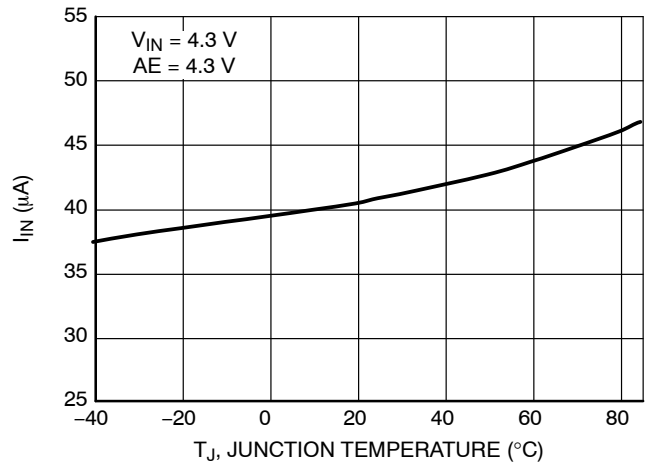


Figure 34. Supply Current vs. Temperature, 3.3 V Version

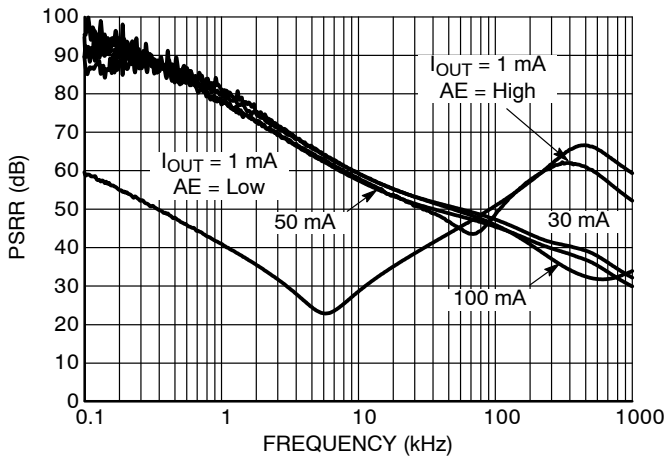


Figure 35. PSRR, 1.0 V Version, $V_{IN} = 2.2$ V

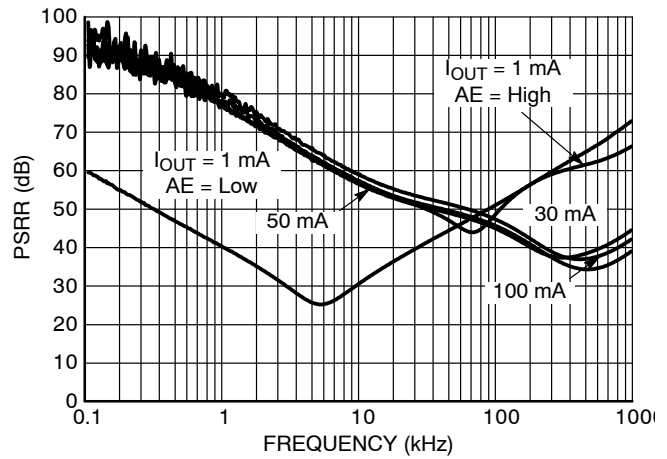


Figure 36. PSRR, 1.2 V Version, $V_{IN} = 2.2$ V

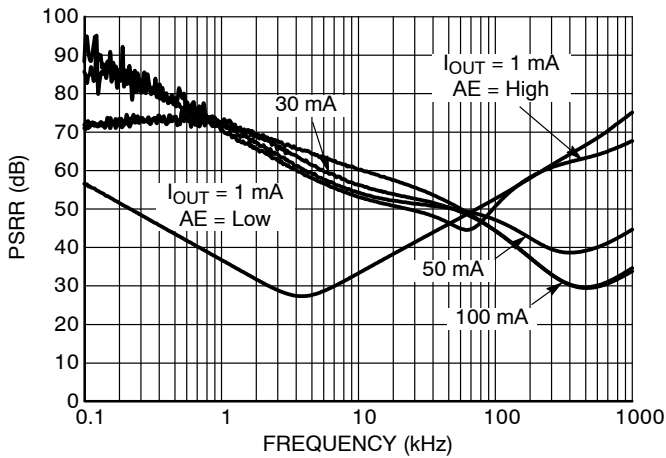


Figure 37. PSRR, 1.8 V Version, $V_{IN} = 3.8$ V

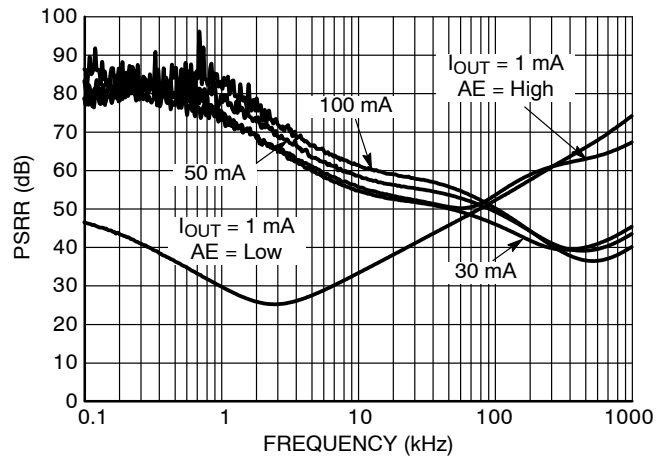


Figure 38. PSRR, 3.3 V Version, $V_{IN} = 4.3$ V

TYPICAL CHARACTERISTICS

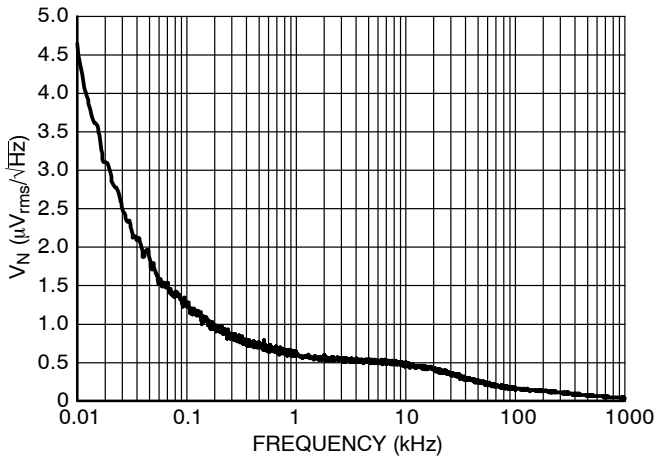


Figure 39. Output Voltage Noise, 1.0 V Version, $V_{IN} = 2.0\text{ V}$, $I_{OUT} = 30\text{ mA}$

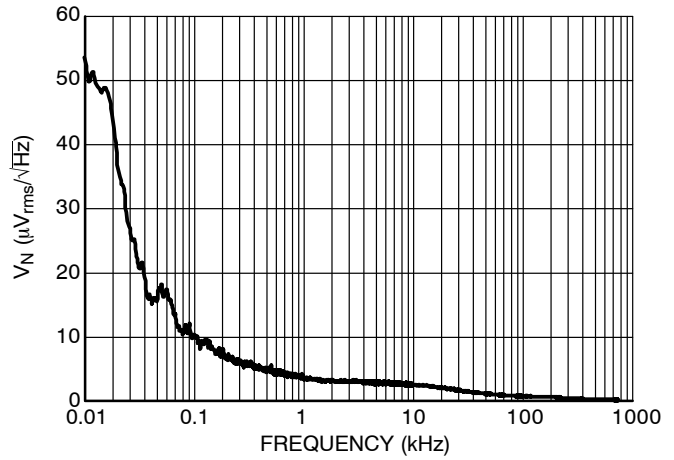


Figure 40. Output Voltage Noise, 1.2 V Version, $V_{IN} = 2.2\text{ V}$, $I_{OUT} = 30\text{ mA}$

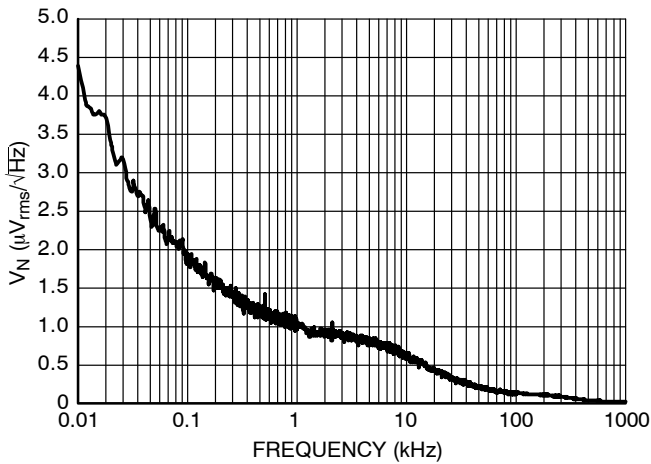


Figure 41. Output Voltage Noise, 1.8 V Version, $V_{IN} = 2.8\text{ V}$, $I_{OUT} = 30\text{ mA}$

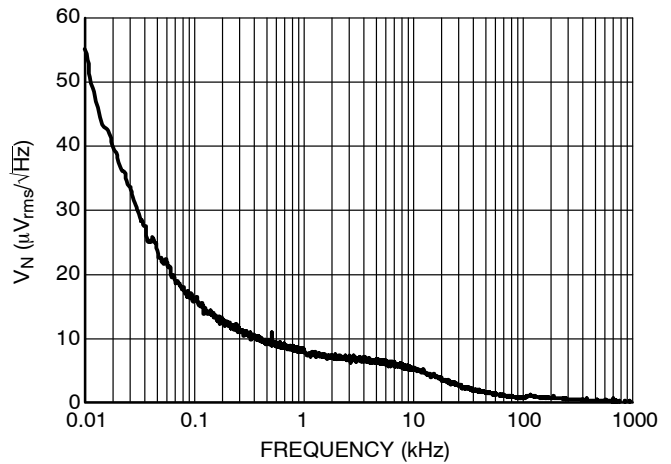


Figure 42. Output Voltage Noise, 3.3 V Version, $V_{IN} = 4.3\text{ V}$, $I_{OUT} = 30\text{ mA}$

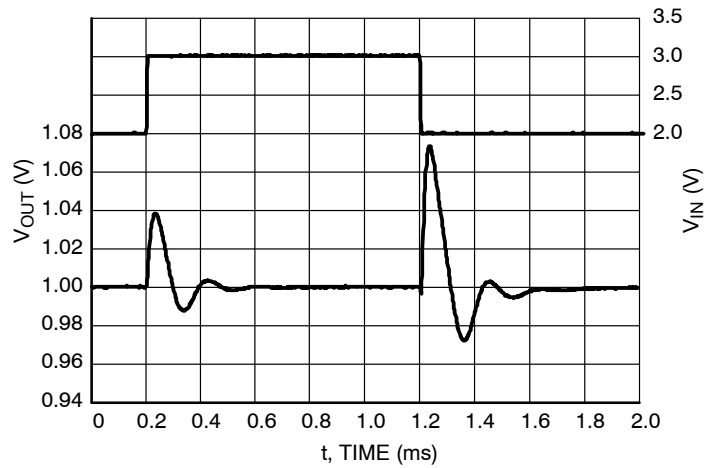
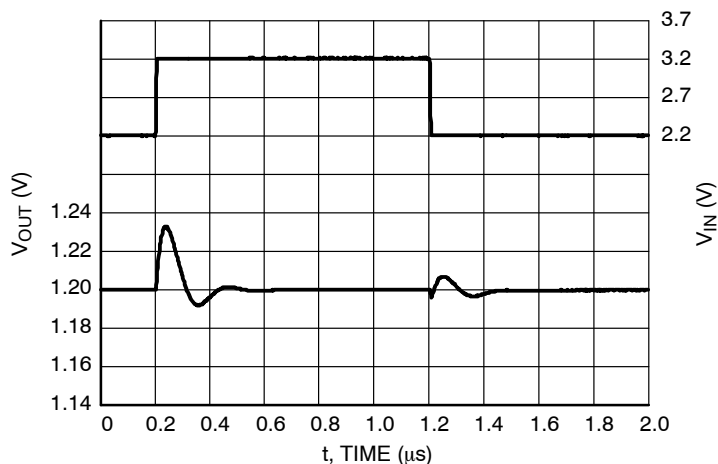


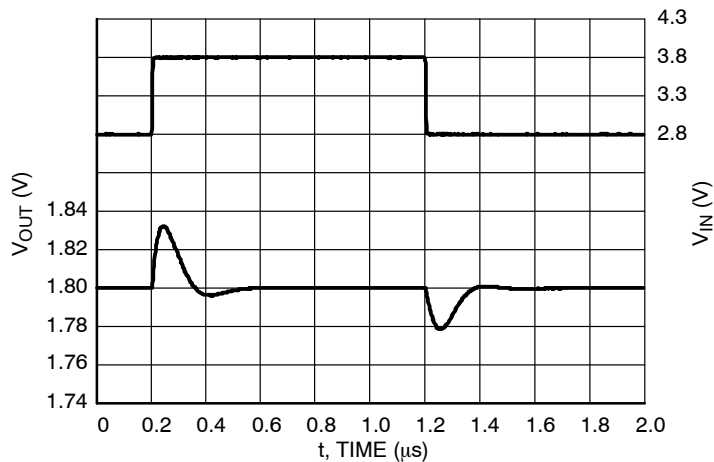
Figure 43. Line Transients, 1.0 V Version, $t_R = t_F = 5\text{ }\mu\text{s}$, $I_{OUT} = 1\text{ mA}$, $AE = 0\text{ V}$

NCP4589

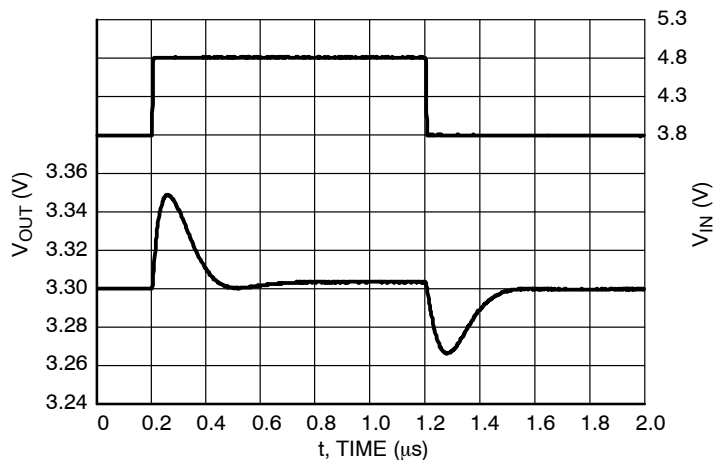
TYPICAL CHARACTERISTICS



**Figure 44. Line Transients, 1.2 V Version,
 $t_R = t_F = 5 \mu\text{s}$, $I_{OUT} = 1 \text{ mA}$, $AE = 0 \text{ V}$**



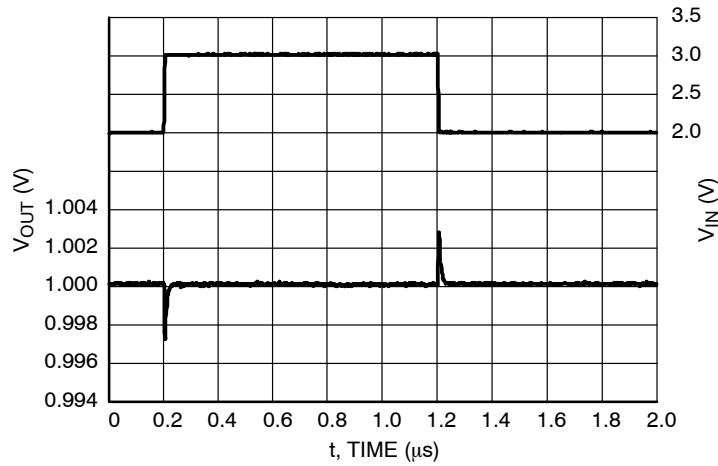
**Figure 45. Line Transients, 1.8 V Version,
 $t_R = t_F = 5 \mu\text{s}$, $I_{OUT} = 1 \text{ mA}$, $AE = 0 \text{ V}$**



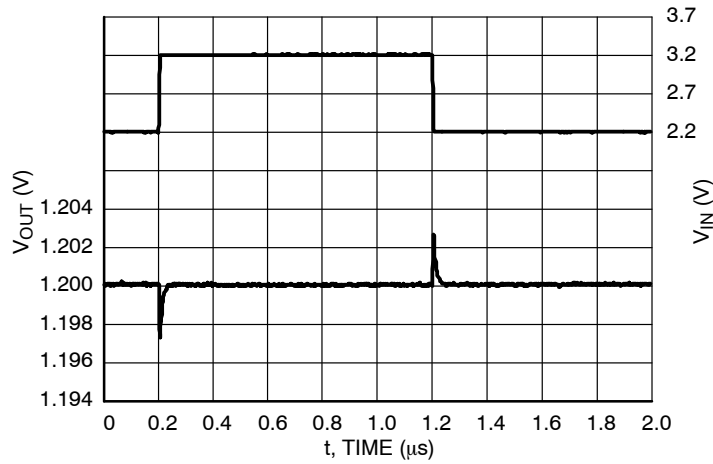
**Figure 46. Line Transients, 3.3 V Version,
 $t_R = t_F = 5 \mu\text{s}$, $I_{OUT} = 1 \text{ mA}$, $AE = 0 \text{ V}$**

NCP4589

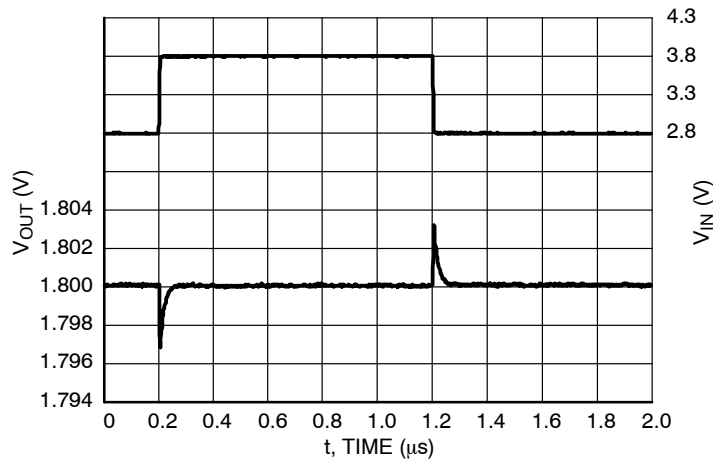
TYPICAL CHARACTERISTICS



**Figure 47. Line Transients, 1.0 V Version,
 $t_R = t_F = 5 \mu s$, $I_{OUT} = 30 \text{ mA}$, $AE = V_{IN} \text{ V}$**



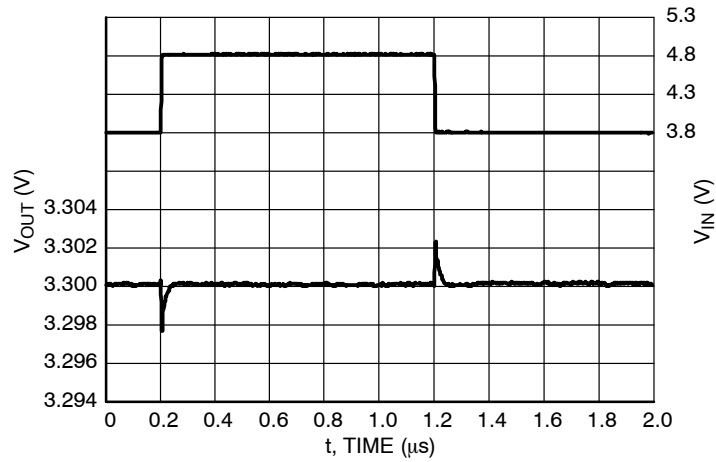
**Figure 48. Line Transients, 1.2 V Version,
 $t_R = t_F = 5 \mu s$, $I_{OUT} = 30 \text{ mA}$, $AE = V_{IN} \text{ V}$**



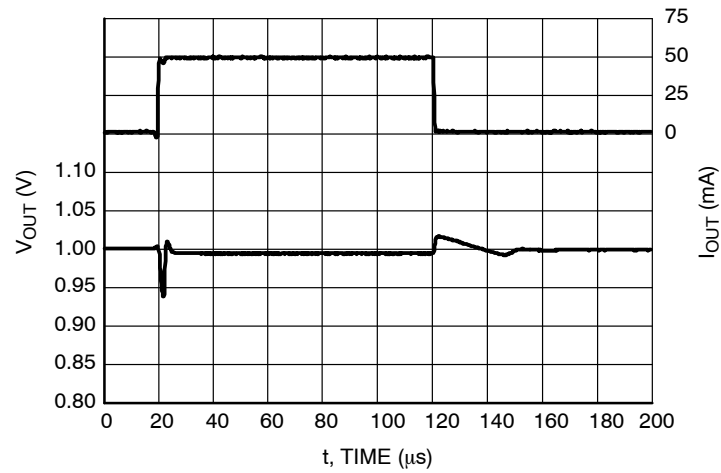
**Figure 49. Line Transients, 1.8 V Version,
 $t_R = t_F = 5 \mu s$, $I_{OUT} = 30 \text{ mA}$, $AE = V_{IN} \text{ V}$**

NCP4589

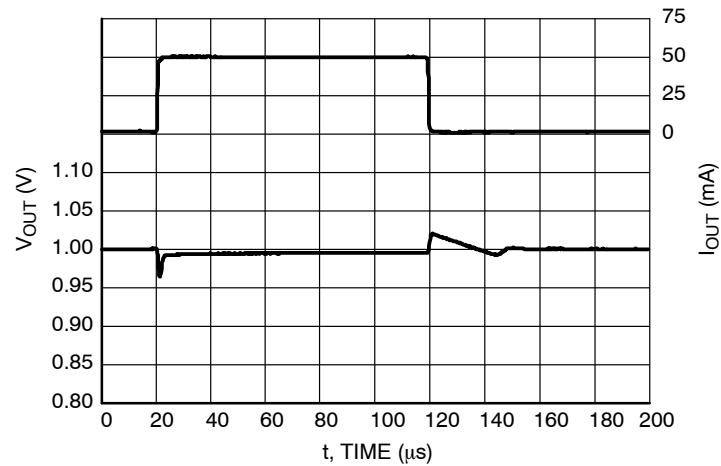
TYPICAL CHARACTERISTICS



**Figure 50. Line Transients, 3.3 V Version,
 $t_R = t_F = 5 \mu\text{s}$, $I_{OUT} = 30 \text{ mA}$, $AE = V_{IN} \text{ V}$**



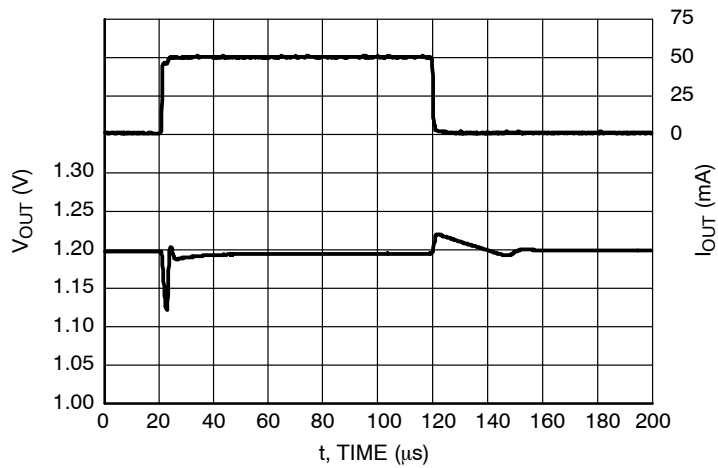
**Figure 51. Load Transients, 1.0 V Version,
 $I_{OUT} = 1 - 50 \text{ mA}$, $t_R = t_F = 0.5 \mu\text{s}$, $V_{IN} = 2.0 \text{ V}$,
 $AE = 0 \text{ V}$**



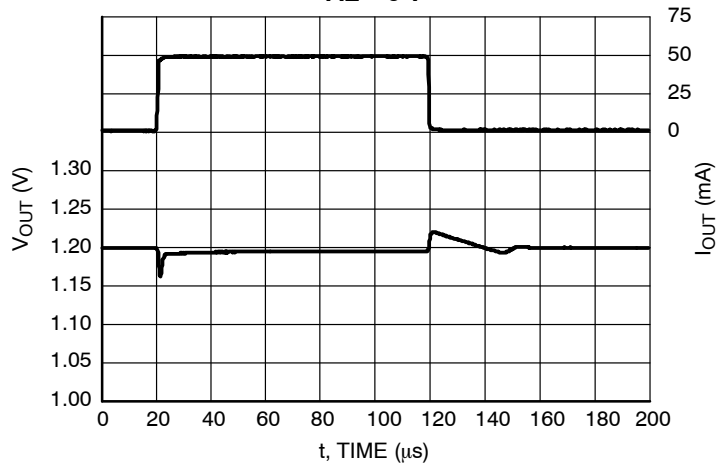
**Figure 52. Load Transients, 1.0 V Version,
 $I_{OUT} = 1 - 50 \text{ mA}$, $t_R = t_F = 0.5 \mu\text{s}$, $V_{IN} = 2.0 \text{ V}$,
 $AE = V_{IN} \text{ V}$**

NCP4589

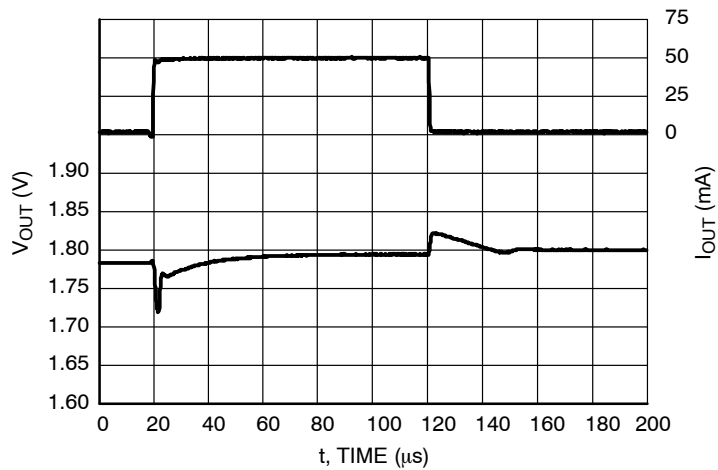
TYPICAL CHARACTERISTICS



**Figure 53. Load Transients, 1.2 V Version,
 $I_{OUT} = 1 - 50 \text{ mA}$, $t_R = t_F = 0.5 \mu\text{s}$, $V_{IN} = 2.2 \text{ V}$,
 $AE = 0 \text{ V}$**

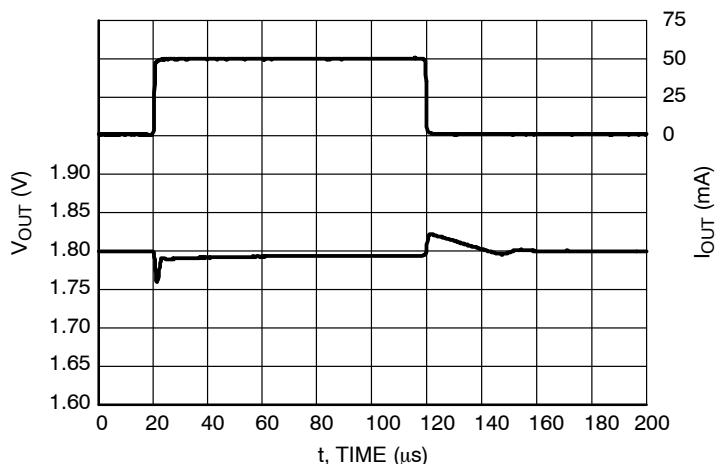


**Figure 54. Load Transients, 1.2 V Version,
 $I_{OUT} = 1 - 50 \text{ mA}$, $t_R = t_F = 0.5 \mu\text{s}$, $V_{IN} = 2.2 \text{ V}$,
 $AE = V_{IN} \text{ V}$**

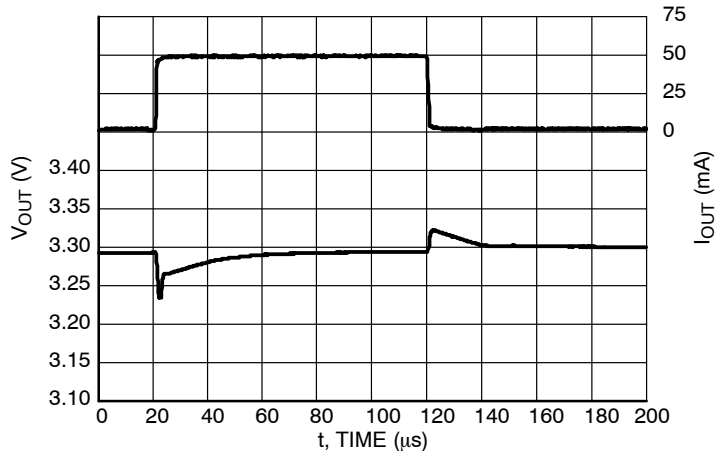


**Figure 55. Load Transients, 1.8 V Version,
 $I_{OUT} = 1 - 50 \text{ mA}$, $t_R = t_F = 0.5 \mu\text{s}$, $V_{IN} = 2.8 \text{ V}$,
 $AE = 0 \text{ V}$**

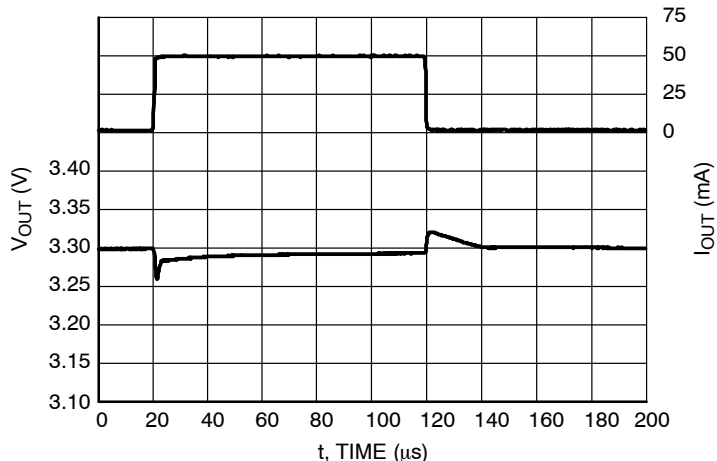
TYPICAL CHARACTERISTICS



**Figure 56. Load Transients, 1.8 V Version,
 $I_{OUT} = 1 - 50 \text{ mA}$, $t_R = t_F = 0.5 \text{ } \mu\text{s}$, $V_{IN} = 2.8 \text{ V}$,
 $AE = V_{IN} \text{ V}$**



**Figure 57. Load Transients, 3.3 V Version,
 $I_{OUT} = 1 - 50 \text{ mA}$, $t_R = t_F = 0.5 \text{ } \mu\text{s}$, $V_{IN} = 4.3 \text{ V}$,
 $AE = 0 \text{ V}$**



**Figure 58. Load Transients, 3.3 V Version,
 $I_{OUT} = 1 - 50 \text{ mA}$, $t_R = t_F = 0.5 \text{ } \mu\text{s}$, $V_{IN} = 4.3 \text{ V}$,
 $AE = V_{IN} \text{ V}$**

NCP4589

TYPICAL CHARACTERISTICS

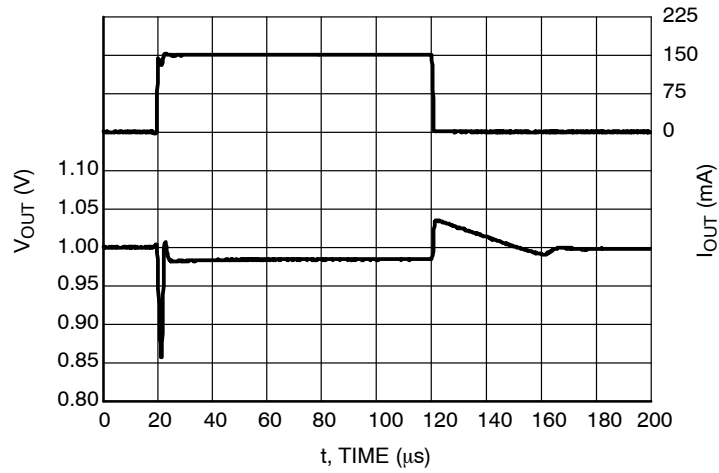


Figure 59. Load Transients, 1.0 V Version,
 $I_{OUT} = 1 - 150 \text{ mA}$, $t_R = t_F = 0.5 \mu\text{s}$, $V_{IN} = 2.0 \text{ V}$,
 $AE = 0 \text{ V}$

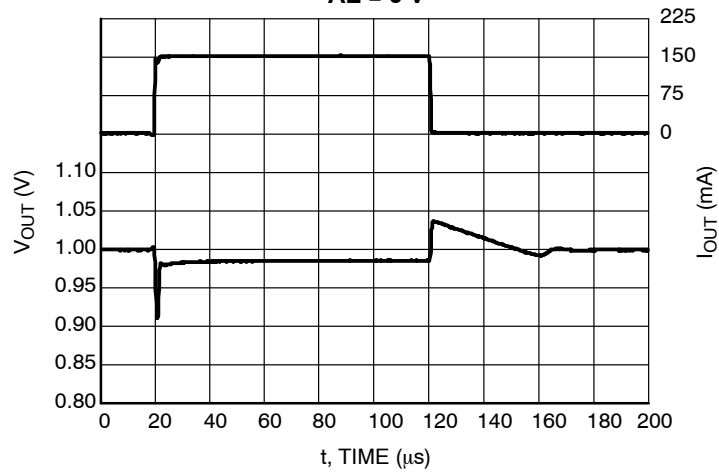


Figure 60. Load Transients, 1.0 V Version,
 $I_{OUT} = 1 - 150 \text{ mA}$, $t_R = t_F = 0.5 \mu\text{s}$, $V_{IN} = 2.0 \text{ V}$,
 $AE = V_{IN} \text{ V}$

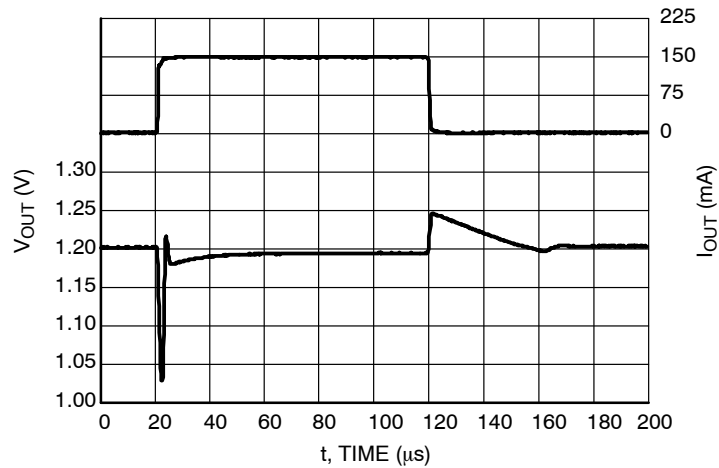
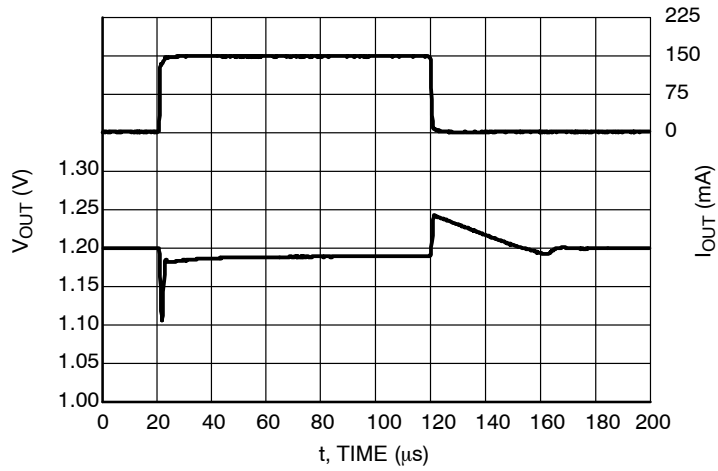


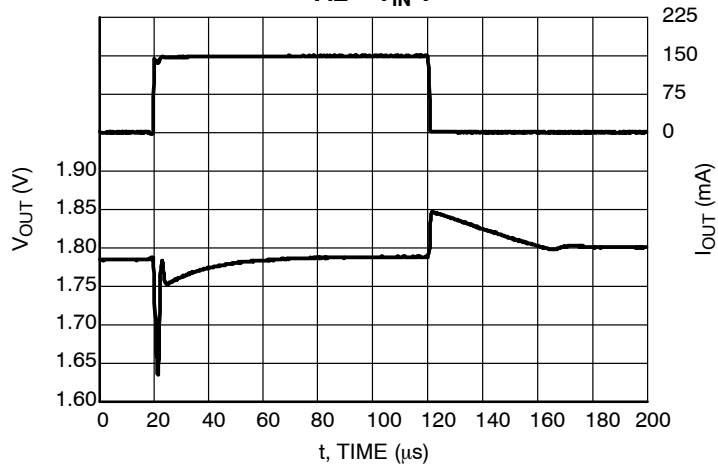
Figure 61. Load Transients, 1.2 V Version,
 $I_{OUT} = 1 - 150 \text{ mA}$, $t_R = t_F = 0.5 \mu\text{s}$, $V_{IN} = 2.2 \text{ V}$,
 $AE = 0 \text{ V}$

NCP4589

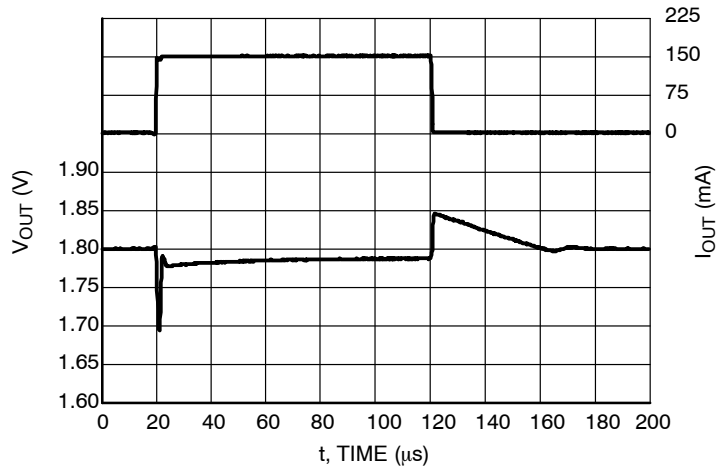
TYPICAL CHARACTERISTICS



**Figure 62. Load Transients, 1.2 V Version,
I_{OUT} = 1 - 150 mA, t_R = t_F = 0.5 μs, V_{IN} = 2.2 V,
AE = V_{IN} V**



**Figure 63. Load Transients, 1.8 V Version,
I_{OUT} = 1 - 150 mA, t_R = t_F = 0.5 μs, V_{IN} = 2.8 V,
AE = 0 V**



**Figure 64. Load Transients, 1.8 V Version,
I_{OUT} = 1 - 150 mA, t_R = t_F = 0.5 μs, V_{IN} = 2.8 V,
AE = V_{IN} V**

NCP4589

TYPICAL CHARACTERISTICS

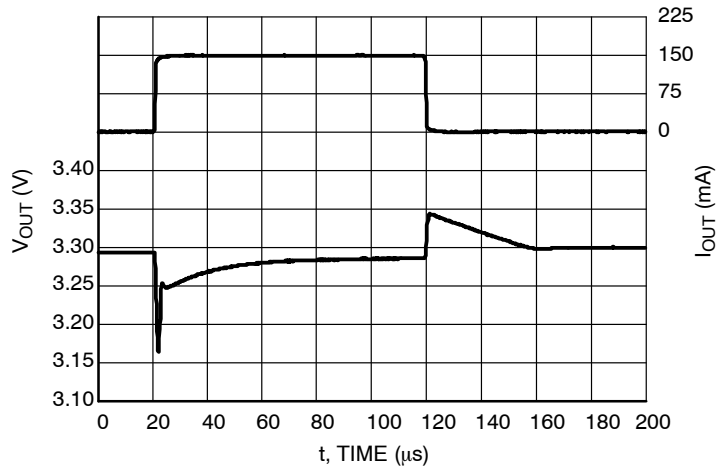


Figure 65. Load Transients, 3.3 V Version,
 $I_{OUT} = 1 - 150 \text{ mA}$, $t_R = t_F = 0.5 \mu\text{s}$, $V_{IN} = 4.3 \text{ V}$,
 $AE = 0 \text{ V}$

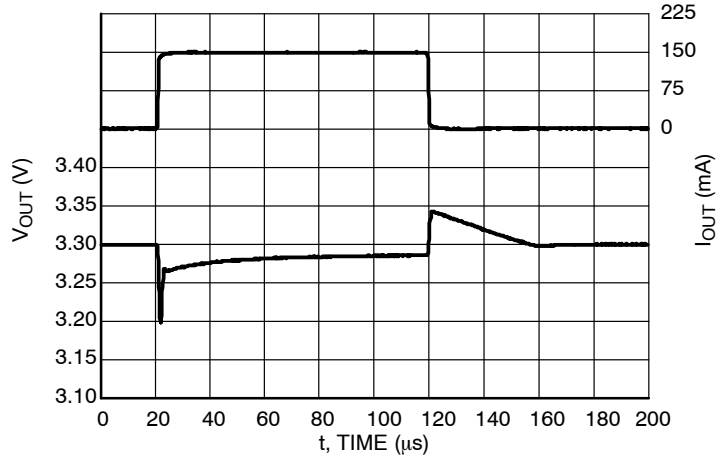


Figure 66. Load Transients, 3.3 V Version,
 $I_{OUT} = 1 - 150 \text{ mA}$, $t_R = t_F = 0.5 \mu\text{s}$, $V_{IN} = 4.3 \text{ V}$,
 $AE = V_{IN} \text{ V}$

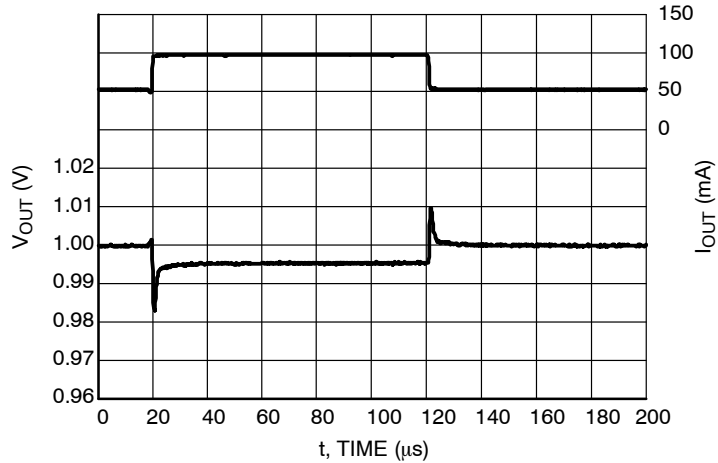


Figure 67. Load Transients, 1.0 V Version,
 $I_{OUT} = 50 - 100 \text{ mA}$, $t_R = t_F = 0.5 \mu\text{s}$, $V_{IN} = 2.0 \text{ V}$,
 $AE = 0 \text{ V}$

NCP4589

TYPICAL CHARACTERISTICS

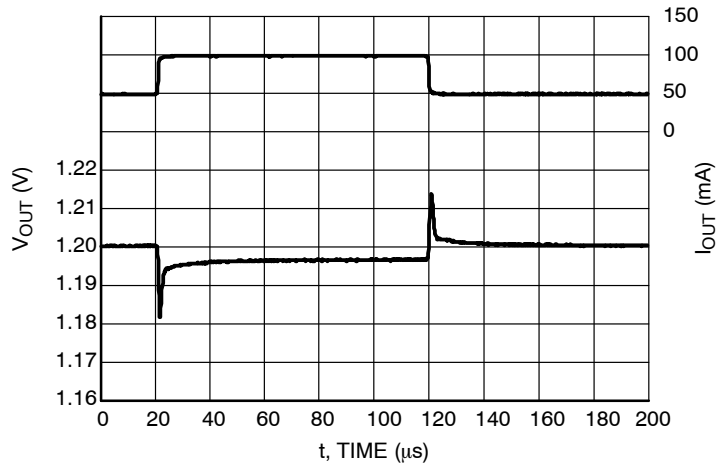


Figure 68. Load Transients, 1.2 V Version,
 $I_{OUT} = 50 - 100 \text{ mA}$, $t_R = t_F = 0.5 \mu\text{s}$, $V_{IN} = 2.2 \text{ V}$,
 $AE = V_{IN} \text{ V}$

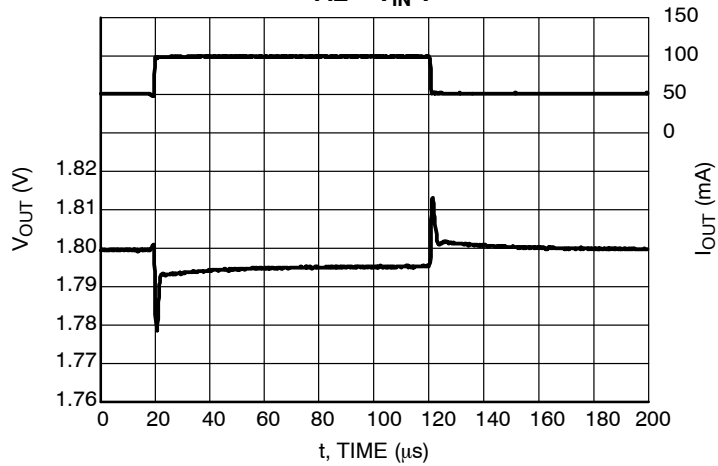


Figure 69. Load Transients, 1.8 V Version,
 $I_{OUT} = 50 - 100 \text{ mA}$, $t_R = t_F = 0.5 \mu\text{s}$, $V_{IN} = 2.8 \text{ V}$,
 $AE = V_{IN} \text{ V}$

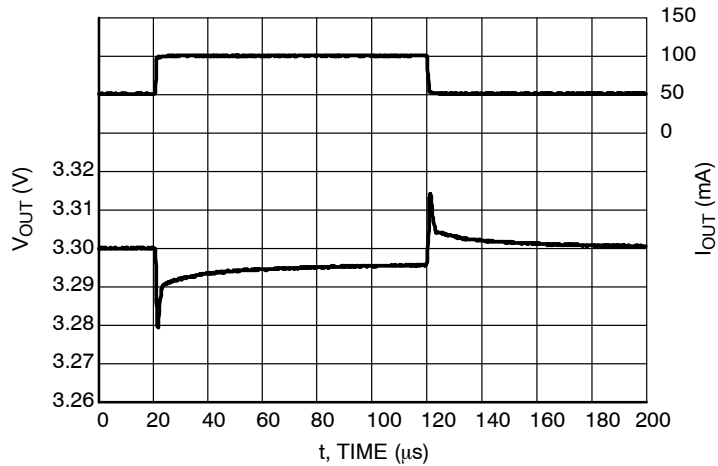


Figure 70. Load Transients, 3.3 V Version,
 $I_{OUT} = 50 - 100 \text{ mA}$, $t_R = t_F = 0.5 \mu\text{s}$, $V_{IN} = 4.3 \text{ V}$,
 $AE = V_{IN} \text{ V}$

TYPICAL CHARACTERISTICS

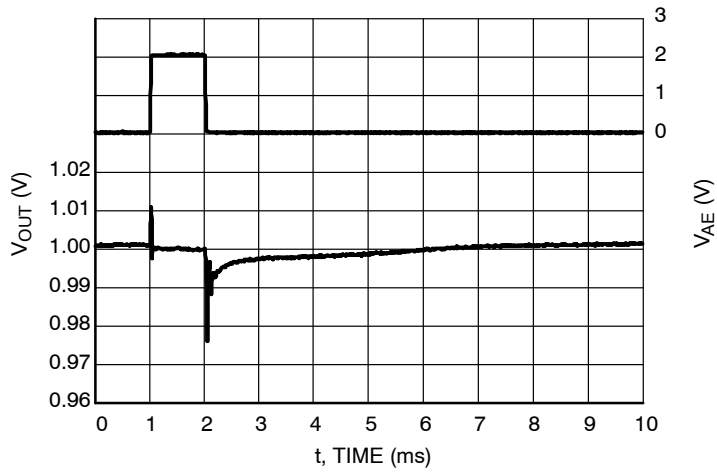


Figure 71. AE Switch Transients, 1.0 V Version,
 $V_{IN} = 2.0\text{ V}$, $I_{OUT} = 1\text{ mA}$

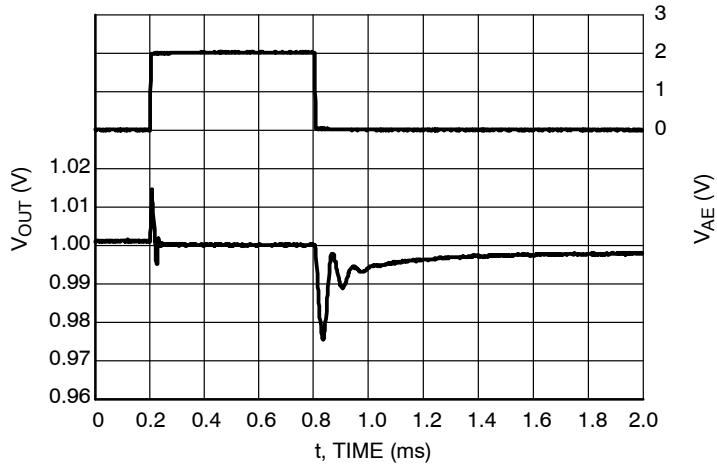


Figure 72. AE Switch Transients, 1.0 V Version,
 $V_{IN} = 2.0\text{ V}$, $I_{OUT} = 1\text{ mA}$

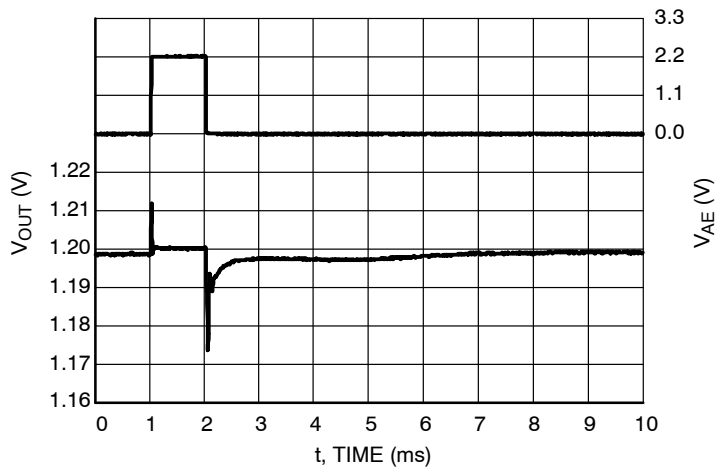


Figure 73. AE Switch Transients, 1.2 V Version,
 $V_{IN} = 2.2\text{ V}$, $I_{OUT} = 1\text{ mA}$

NCP4589

TYPICAL CHARACTERISTICS

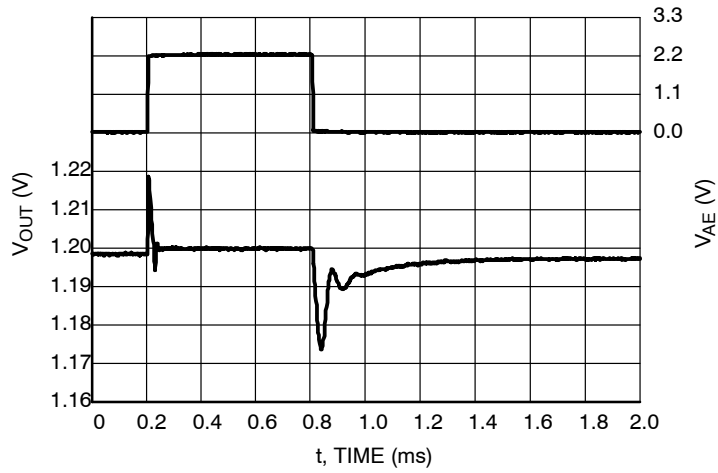


Figure 74. AE Switch Transients, 1.2 V Version,
 $V_{IN} = 2.2$ V, $I_{OUT} = 1$ mA

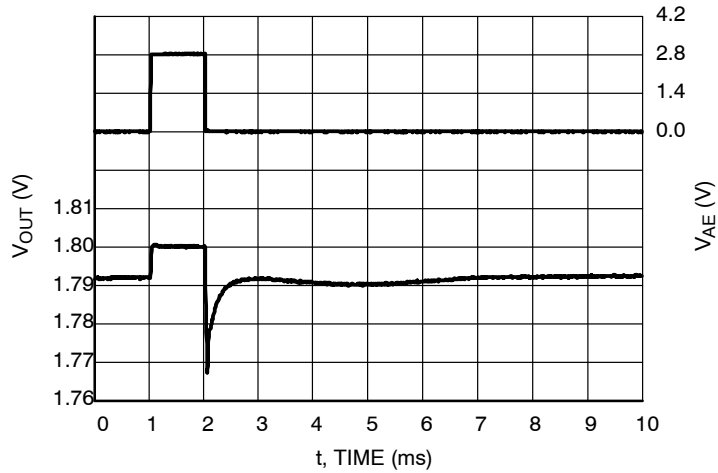


Figure 75. AE Switch Transients, 1.8 V Version,
 $V_{IN} = 2.8$ V, $I_{OUT} = 1$ mA

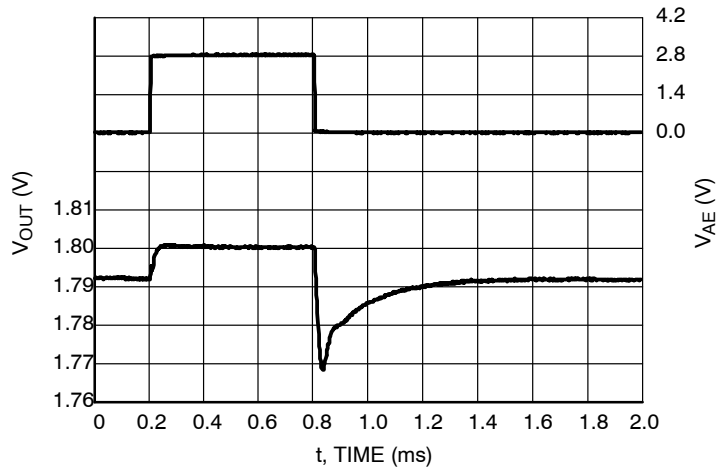


Figure 76. AE Switch Transients, 1.8 V Version,
 $V_{IN} = 2.8$ V, $I_{OUT} = 1$ mA

NCP4589

TYPICAL CHARACTERISTICS

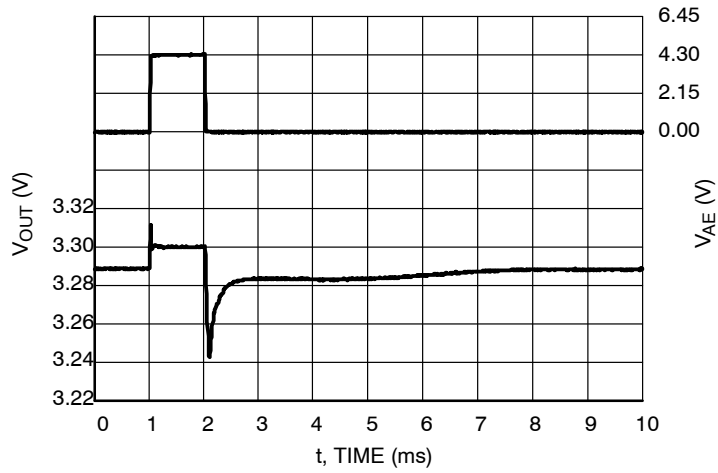


Figure 77. AE Switch Transients, 3.3 V Version,
 $V_{IN} = 4.3 \text{ V}$, $I_{OUT} = 1 \text{ mA}$

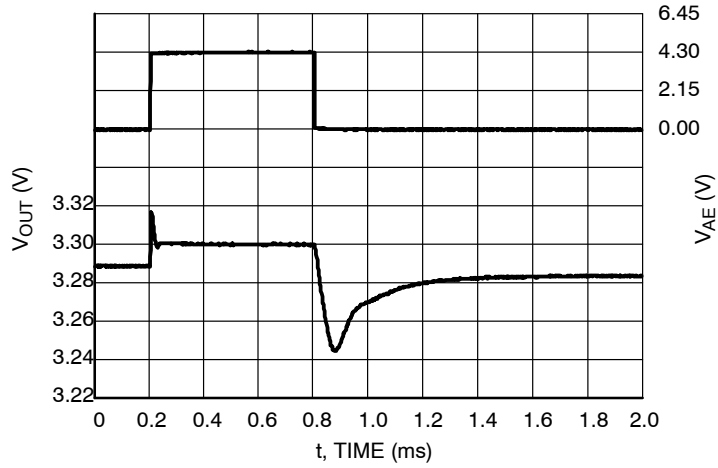


Figure 78. AE Switch Transients, 3.3 V Version,
 $V_{IN} = 4.3 \text{ V}$, $I_{OUT} = 1 \text{ mA}$

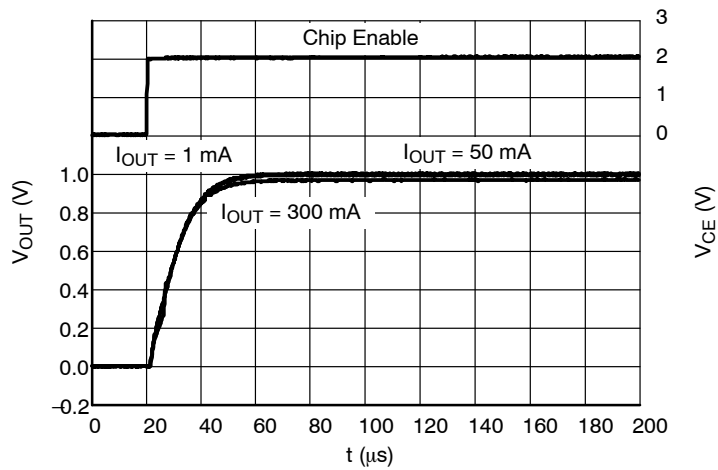


Figure 79. Start-up, 1.0 V Version, $V_{IN} = 2.0 \text{ V}$

NCP4589

TYPICAL CHARACTERISTICS

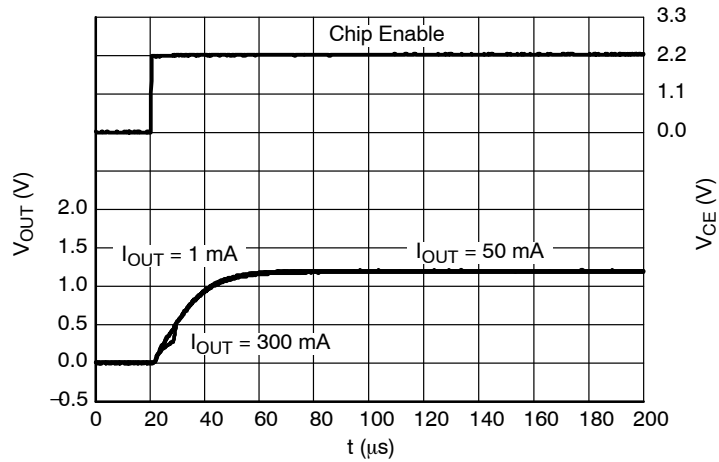


Figure 80. Start-up, 1.2 V Version, $V_{IN} = 2.2$ V

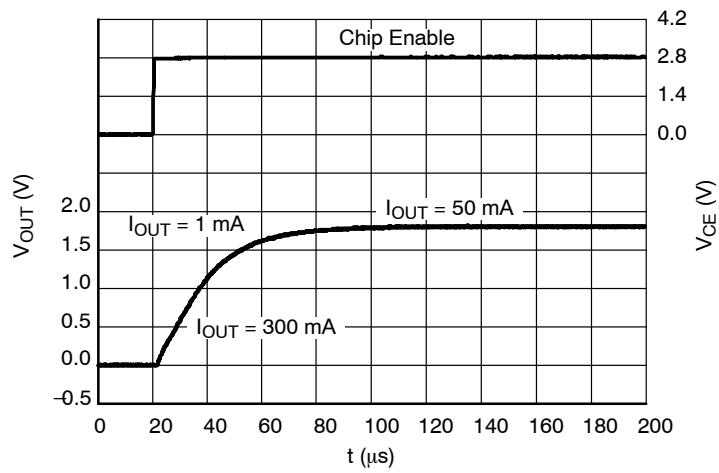


Figure 81. Start-up, 1.8 V Version, $V_{IN} = 2.8$ V

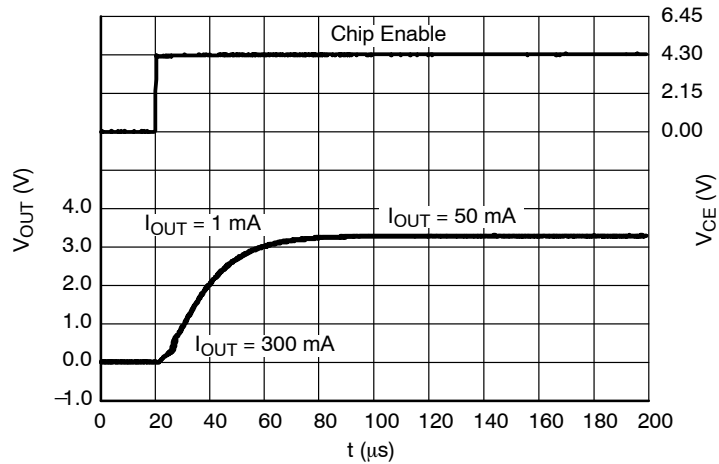
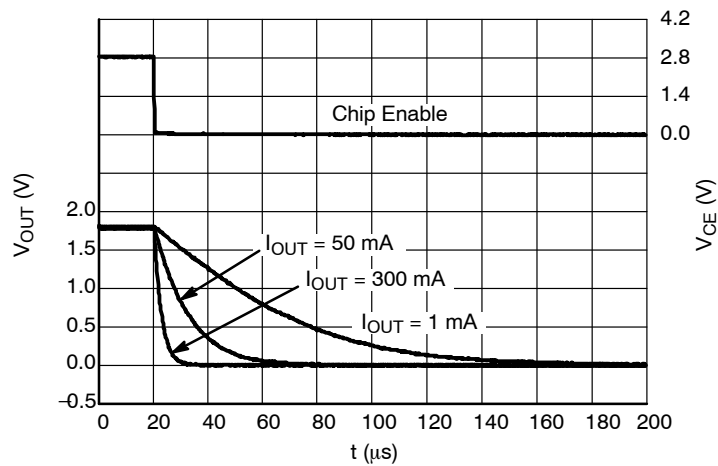
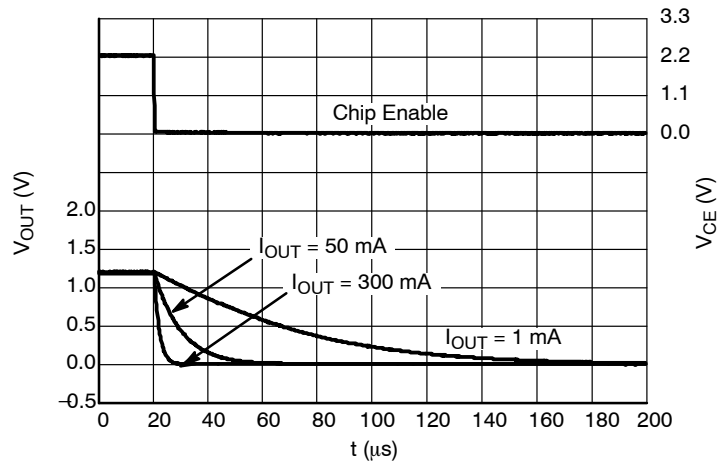
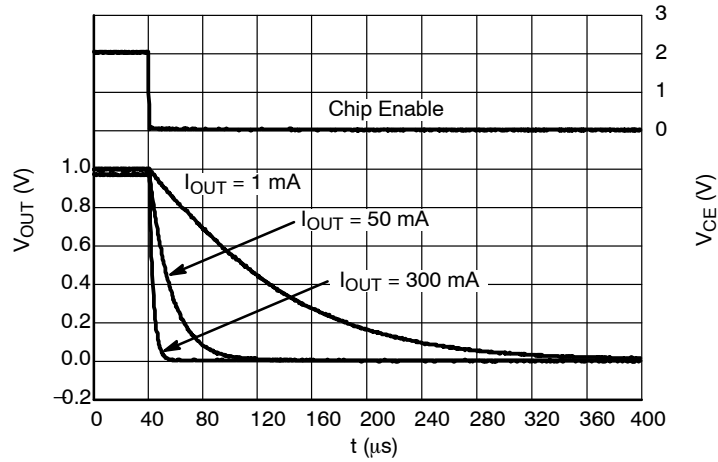


Figure 82. Start-up, 3.3 V Version, $V_{IN} = 4.3$ V

NCP4589

TYPICAL CHARACTERISTICS



NCP4589

TYPICAL CHARACTERISTICS

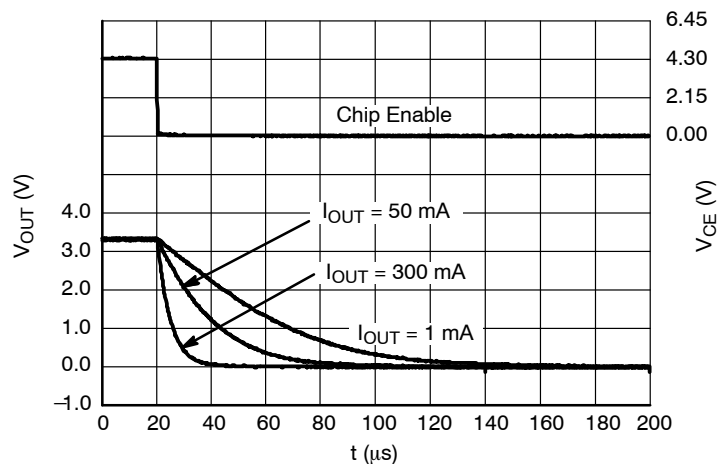


Figure 86. Shutdown, 3.3 V Version D,
 $V_{IN} = 4.3 V$

APPLICATION INFORMATION

A typical application circuit for NCP4589 series is shown in Figure 87.

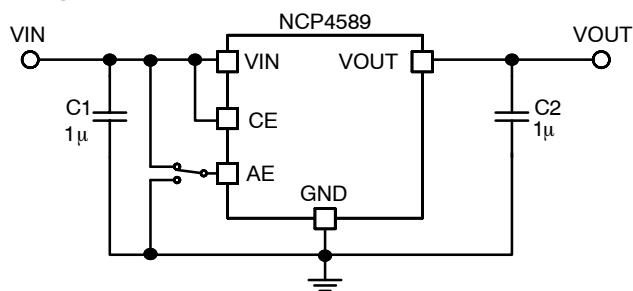


Figure 87. Typical Application Schematic

Input Decoupling Capacitor (C1)

A 1 μF ceramic input decoupling capacitor should be connected as close as possible to the input and ground pin of the NCP4589. Higher values and lower ESR improves line transient response.

Output Decoupling Capacitor (C2)

A 1 μF ceramic output decoupling capacitor is sufficient to achieve stable operation of the IC. If tantalum capacitor is used, and its ESR is high, the loop oscillation may result. If output capacitor is composed from few ceramic capacitors in parallel, the operation can be unstable. The capacitor should be connected as close as possible to the output and ground pin. Larger values and lower ESR improves dynamic parameters.

Enable Operation

The enable pin CE may be used for turning the regulator on and off. The regulator is switched on when CE pin voltage is above logic high level. The enable pin has internal pull

down current source. If enable function is not needed connect CE pin to V_{IN} .

Current Limit

This regulator includes fold-back type current limit circuit. This type of protection doesn't limit current up to current capability in normal operation, but when over current occurs, the output voltage and current decrease until the over current condition ends. Typical characteristics of this protection type can be observed in the Output Voltage versus Output Current graphs shown in the typical characteristics chapter of this datasheet.

Output Discharger

The D version includes a transistor between V_{OUT} and GND that is used for faster discharging of the output capacitor. This function is activated when the IC goes into disable mode.

Auto ECO and Fast Mode

The NCP4589 has two operation modes that have impact on supply current and transient response at low output current. These two modes can be selected by AE pin. If AE pin is at low level Auto ECO mode is available. Please, see supply current vs. output current charts.

Thermal

As power across the IC increases, it might become necessary to provide some thermal relief. The maximum power dissipation supported by the device is dependent upon board design and layout. Mounting pad configuration on the PCB, the board material, and also the ambient temperature affect the rate of temperature rise for the part. That is to say, when the device has good thermal

NCP4589

conductivity through the PCB, the junction temperature will be relatively low with high power dissipation applications.

capacitors C1 and C2 as close as possible to the IC, and make wiring as short as possible.

PCB layout

Make V_{IN} and GND line sufficient. If their impedance is high, noise pickup or unstable operation may result. Connect

ORDERING INFORMATION

Device	Nominal Output Voltage	Description	Marking	Package	Shipping [†]
NCP4589DSQ12T1G	1.2 V	Auto discharge	D012	SC-70 (Pb-Free)	3000 / Tape & Reel
NCP4589DSQ18T1G	1.8 V	Auto discharge	D018	SC-70 (Pb-Free)	3000 / Tape & Reel
NCP4589DSQ25T1G	2.5 V	Auto discharge	D025	SC-70 (Pb-Free)	3000 / Tape & Reel
NCP4589DSQ30T1G	3.0 V	Auto discharge	D030	SC-70 (Pb-Free)	3000 / Tape & Reel
NCP4589DSQ33T1G	3.3 V	Auto discharge	D033	SC-70 (Pb-Free)	3000 / Tape & Reel
NCP4589DSN12T1G	1.2 V	Auto discharge	P1E	SOT-23-5 (Pb-Free)	3000 / Tape & Reel
NCP4589DSN18T1G	1.8 V	Auto discharge	P1L	SOT-23-5 (Pb-Free)	3000 / Tape & Reel
NCP4589DSN25T1G	2.5 V	Auto discharge	P1T	SOT-23-5 (Pb-Free)	3000 / Tape & Reel
NCP4589DSN30T1G	3.0 V	Auto discharge	P1Y	SOT-23-5 (Pb-Free)	3000 / Tape & Reel
NCP4589DSN33T1G	3.3 V	Auto discharge	Q1B	SOT-23-5 (Pb-Free)	3000 / Tape & Reel
NCP4589DMX12TCG	1.2 V	Auto discharge	7E	XDFN (Pb-Free)	5000 / Tape & Reel
NCP4589DMX18TCG	1.8 V	Auto discharge	7L	XDFN (Pb-Free)	5000 / Tape & Reel
NCP4589DMX28TCG	2.8 V	Auto discharge	7W	XDFN (Pb-Free)	5000 / Tape & Reel
NCP4589DMX30TCG	3.0 V	Auto discharge	7Y	XDFN (Pb-Free)	5000 / Tape & Reel
NCP4589DMX33TCG	3.3 V	Auto discharge	8B	XDFN (Pb-Free)	5000 / Tape & Reel

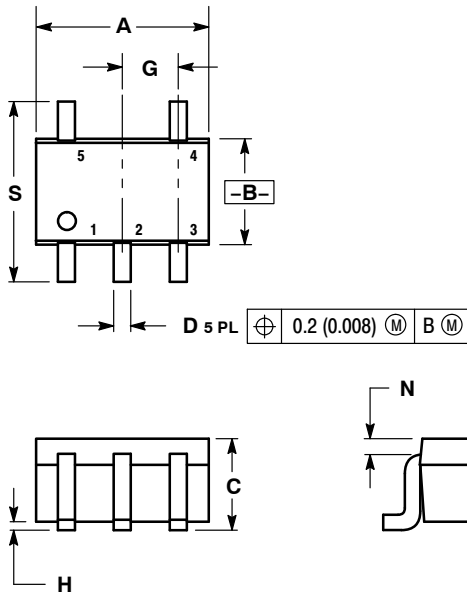
[†]For information on tape and reel specifications, including part orientation and tape sizes, please refer to our Tape and Reel Packaging Specifications Brochure, BRD8011/D.

NOTE: To order other package and voltage variants, please contact your ON Semiconductor sales representative.

NCP4589

PACKAGE DIMENSIONS

SC-88A (SC-70-5/SOT-353)
CASE 419A-02
ISSUE K



NOTES:

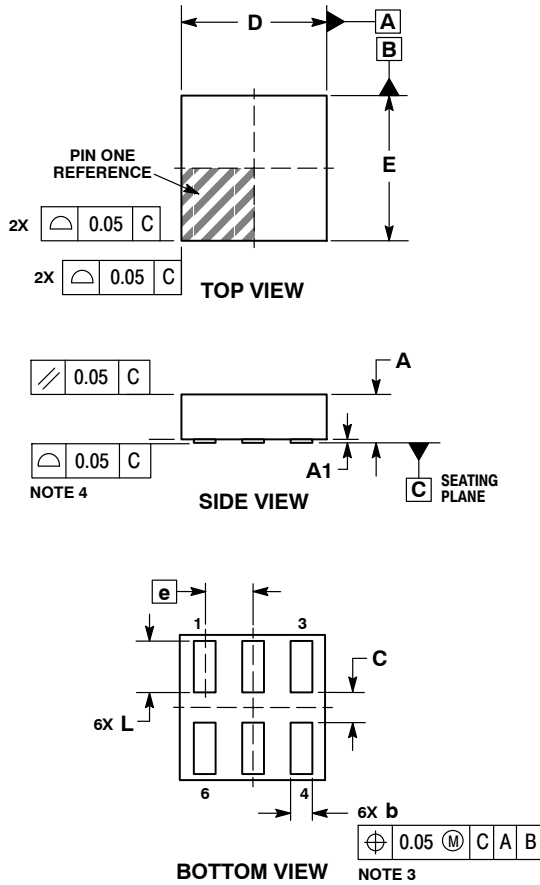
1. DIMENSIONING AND TOLERANCING PER ANSI Y14.5M, 1982.
2. CONTROLLING DIMENSION: INCH.
3. 419A-01 OBSOLETE. NEW STANDARD 419A-02.
4. DIMENSIONS A AND B DO NOT INCLUDE MOLD FLASH, PROTRUSIONS, OR GATE BURRS.

DIM	INCHES		MILLIMETERS	
	MIN	MAX	MIN	MAX
A	0.071	0.087	1.80	2.20
B	0.045	0.053	1.15	1.35
C	0.031	0.043	0.80	1.10
D	0.004	0.012	0.10	0.30
G	0.026 BSC		0.65 BSC	
H	---	0.004	---	0.10
J	0.004	0.010	0.10	0.25
K	0.004	0.012	0.10	0.30
N	0.008 REF		0.20 REF	
S	0.079	0.087	2.00	2.20

NCP4589

PACKAGE DIMENSIONS

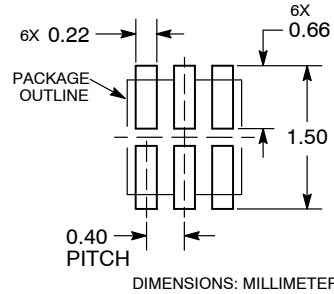
XDFN6 1.2x1.2, 0.4P
CASE 711AA-01
ISSUE O



- NOTES:
1. DIMENSIONING AND TOLERANCING PER ASME Y14.5M, 1994.
 2. CONTROLLING DIMENSION: MILLIMETERS.
 3. DIMENSION b APPLIES TO PLATED TERMINAL AND IS MEASURED BETWEEN 0.15 AND 0.25mm FROM TERMINAL TIPS.
 4. COPLANARITY APPLIES TO ALL OF THE TERMINALS.

DIM	MILLIMETERS	
	MIN	MAX
A	---	0.40
A1	0.00	0.05
b	0.13	0.23
C	0.20	0.30
D	1.20 BSC	
E	1.20 BSC	
e	0.40 BSC	
L	0.37	0.48

RECOMMENDED MOUNTING FOOTPRINT*

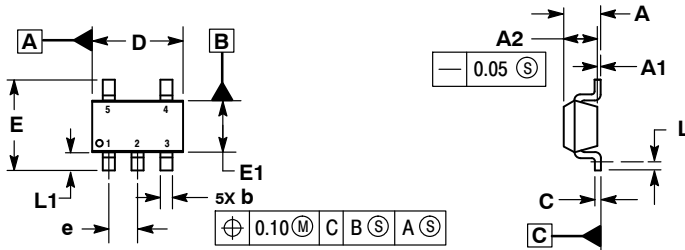


*For additional information on our Pb-Free strategy and soldering details, please download the ON Semiconductor Soldering and Mounting Techniques Reference Manual, SOLDERRM/D.

NCP4589

PACKAGE DIMENSIONS

SOT-23 5-LEAD CASE 1212-01 ISSUE A

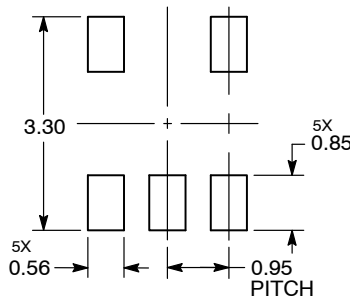


NOTES:

1. DIMENSIONING AND TOLERANCING PER ASME Y14.5M, 1994.
2. CONTROLLING DIMENSIONS: MILLIMETERS.
3. DATUM C IS THE SEATING PLANE.


MILLIMETERS		
DIM	MIN	MAX
A	---	1.45
A1	0.00	0.10
A2	1.00	1.30
b	0.30	0.50
c	0.10	0.25
D	2.70	3.10
E	2.50	3.10
E1	1.50	1.80
e	0.95 BSC	
L	0.20	---
L1	0.45	0.75

RECOMMENDED SOLDERING FOOTPRINT*



DIMENSIONS: MILLIMETERS

*For additional information on our Pb-Free strategy and soldering details, please download the ON Semiconductor Soldering and Mounting Techniques Reference Manual, SOLDERRM/D.

ON Semiconductor and  are registered trademarks of Semiconductor Components Industries, LLC (SCILLC). SCILLC reserves the right to make changes without further notice to any products herein. SCILLC makes no warranty, representation or guarantee regarding the suitability of its products for any particular purpose, nor does SCILLC assume any liability arising out of the application or use of any product or circuit, and specifically disclaims any and all liability, including without limitation special, consequential or incidental damages. "Typical" parameters which may be provided in SCILLC data sheets and/or specifications can and do vary in different applications and actual performance may vary over time. All operating parameters, including "Typicals" must be validated for each customer application by customer's technical experts. SCILLC does not convey any license under its patent rights nor the rights of others. SCILLC products are not designed, intended, or authorized for use as components in systems intended for surgical implant into the body, or other applications intended to support or sustain life, or for any other application in which the failure of the SCILLC product could create a situation where personal injury or death may occur. Should Buyer purchase or use SCILLC products for any such unintended or unauthorized application, Buyer shall indemnify and hold SCILLC and its officers, employees, subsidiaries, affiliates, and distributors harmless against all claims, costs, damages, and expenses, and reasonable attorney fees arising out of, directly or indirectly, any claim of personal injury or death associated with such unintended or unauthorized use, even if such claim alleges that SCILLC was negligent regarding the design or manufacture of the part. SCILLC is an Equal Opportunity/Affirmative Action Employer. This literature is subject to all applicable copyright laws and is not for resale in any manner.

PUBLICATION ORDERING INFORMATION

LITERATURE FULFILLMENT:
Literature Distribution Center for ON Semiconductor
P.O. Box 5163, Denver, Colorado 80217 USA
Phone: 303-675-2175 or 800-344-3860 Toll Free USA/Canada
Fax: 303-675-2176 or 800-344-3867 Toll Free USA/Canada
Email: orderlit@onsemi.com

N. American Technical Support: 800-282-9855 Toll Free
USA/Canada
Europe, Middle East and Africa Technical Support:
Phone: 421 33 790 2910
Japan Customer Focus Center
Phone: 81-3-5817-1050

ON Semiconductor Website: www.onsemi.com
Order Literature: <http://www.onsemi.com/orderlit>

For additional information, please contact your local Sales Representative